



2021

FİYAT LİSTESİ



ankaflex

HİDROLİK PNÖMATİK MAKİNE LTD. ŞTİ.

SOKETLER.....	: 2 - 3
METRİK HORTUM RAKORLARI.....	: 4 - 7
BSP HORTUM RAKORLARI	: 8 - 12
ORFS HORTUM RAKORLARI	: 13 - 15
WITHWORTH UNF HORTUM RAKORLARI	: 16 - 18
FLANŞLI HORTUM RAKORLARI	: 19 - 24
BORU UÇLU HORTUM RAKORLARI	: 25
PRESLİ ARA EK RAKORLAR	: 26
YIKAMA MAKİNASI HORTUM BAŞLIKLARI	: 26
KAYNAKLI PRESLİ DÜZ İÇLER	: 26
GRES HORTUM BAŞLIKLARI	: 27
METRİK PRESLİ DÜZ İÇLER	: 27
METRİK CİVATALAR	: 27
BSP CİVATALAR	: 27
KONTRA SOMUNLAR	: 28
TAPALAR	: 28 - 32
KAYNAKLI NİPELLER	: 32 - 33
MANŞONLAR	: 33
REDÜKSİYONLAR	: 34
NİPELLER	: 35 - 43
MANOMETRE ERKEK RAKORLAR	: 43
PERDE GEÇİŞ NİPELLERİ	: 43

GÜNCEL FİYAT BİLGİSİ İÇİN İLETİŞİME GEÇİNİZ

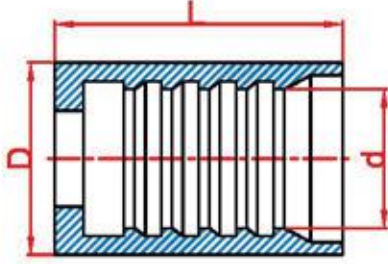

R1 - R2 Soket

Hortum	L	D	d	Fiyat
3/16"	24	18	13	1,80 TL
1/4"	29	20	13.5	1,90 TL
5/16"	30	22	15.5	2,20 TL
3/8"	33	25	18.1	2,60 TL
1/2"	35-38	30-28	21.5	3,30 TL
5/8"	41	32	24	5,70 TL
3/4"	46	38	28.6	7,55 TL
1"	53	45	36.5	12,50 TL
1" 1/4	70	55	46	19,50 TL
1" 1/2	70	62	51.5	22,70 TL
2"	71	75	64.5	24,85 TL
2" 1/2	72	91	79	42,00 TL
3"	85	103	92.5	52,00 TL

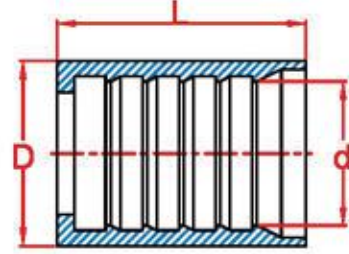

R9 Soket

Hortum	L	D	d	Fiyat
3/8" 4SP	33	25	19	3,10 TL
1/2" 4SP	37,5	30	22	3,80 TL
5/8" 4SP	47	34	25.5	6,30 TL
3/4" 4SP	51	38	29.5	9,00 TL
1" 4SP-SH	63	45	36.5	13,80 TL
1" 1/4 4SH	70	55	44	18,60 TL
1" 1/2 4SH	70	62	50.8	20,20 TL
2" 4SH	71	75	64.5	25,40 TL

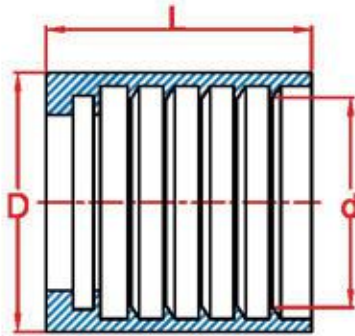

R1-R2 Soymasız Soket

Hortum	L	D	d	Fiyat
1/4"	26.50	22	15.4	3,00 TL
5/16"	27	25	17.1	3,40 TL
3/8"	28	26	19.5	3,25 TL
1/2"	33	30	22.8	4,50 TL
5/8"	36.5	34	26.1	6,80 TL
3/4"	39	38	30.2	8,40 TL
1"	45	50	38.6	15,00 TL

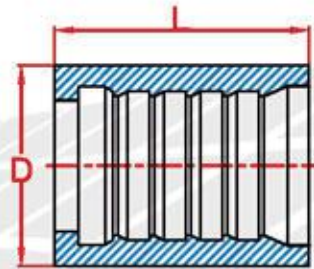

Termoplastik Hortum Soketi (R7-R8)

Hortum	L	D	Fiyat
3/16"	23	14.5	2,60 TL
1/4"	30	17	2,60 TL
5/16"	30	20	2,80 TL
3/8"	32	22	3,40 TL
1/2"	34	25	4,50 TL
5/8"	36	28.5	6,80 TL
3/4"	45	32	9,20 TL
1"	53	38	14,80 TL

GÜNCEL FİYAT BİLGİSİ İÇİN İLETİŞİME GEÇİNİZ

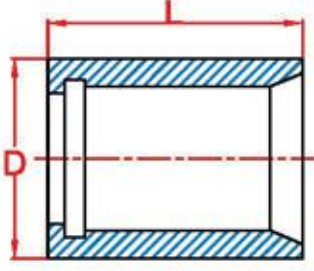

Teflon Soket

Hortum	L	D	Fiyat
3/16"	27	12	2,30 TL
1/4"	30	14	2,30 TL
5/16"	30	16	2,60 TL
3/8"	31	19	2,85 TL
1/2"	34	24	3,90 TL
5/8"	37	27	6,60 TL
3/4"	42	30	8,90 TL
1"	51	36.5	15,65 TL

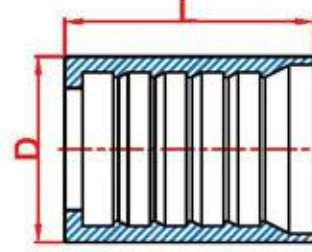

R5 Soket

Hortum	L	D	Fiyat
3/16"	29	20	2,30 TL
1/4"	29	20	2,45 TL
5/16"	32	22	2,85 TL
3/8"	33	26	3,25 TL
1/2"	35	30	4,75 TL
5/8"	41	35	6,60 TL
7/8"	46	38	7,70 TL
1 1/8"	53	45	13,00 TL
1 3/8"	60	55	21,60 TL
1 13/16"	65	67	25,40 TL

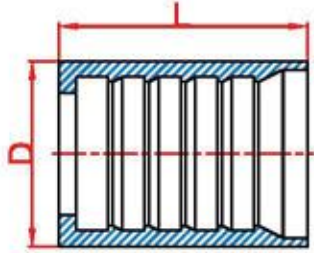

Buhar Hortumlu Soket

Hortum	L	D	Fiyat
1/2"	35	30	4,00 TL
3/4"	46	38	7,60 TL
1"	53	45	12,50 TL
1 1/4"	70	55	22,70 TL
1 1/2"	70	62	25,40 TL
2"	71	75	28,10 TL

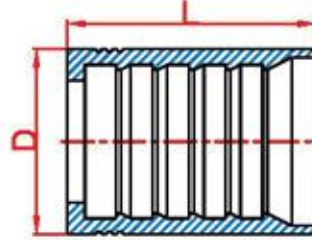

Altı Telli Sıyrımlı Tip Soket

Hortum	L	D	Fiyat
1" 1/4 R13-R15	88	60	46,00 TL
1" 1/2 R13-R15	90	68	54,00 TL
2" R13-R15	102	82	70,00 TL

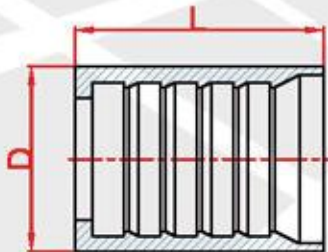

Dört Telli Sıyrımlı Tip Soket

Hortum	L	D	Fiyat
1"	74	45	24,30 TL
1" 1/4	90	55	44,50 TL
1" 1/2	92	62	51,30 TL
2"	99	78	66,20 TL

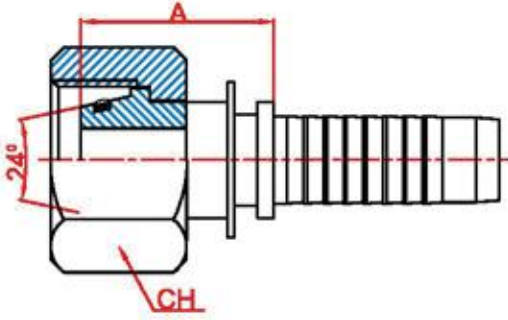
GÜNCEL FİYAT BİLGİSİ İÇİN İLETİŞİME GEÇİNİZ

Metrik (24°) Düz Hortum Rakorları

Hortum	Anma Ölçüsü	CH	A	Fiyat
3/16"	M12x1.5-6L	14	17	3,60 TL
3/16"	M14x1.5-8L	17	17	3,60 TL
1/4"	M12x1.5-6L	14	17.5	4,00 TL
1/4"	M14x1.5-8L	17	17.5	3,40 TL
1/4"	M16x1.5-10L	19	20.5	3,90 TL
1/4"	M18x1.5-12L	22	20.5	4,75 TL
5/16"	M14x1.5-8L	17	17.5	4,60 TL
5/16"	M16x1.5-10L	19	20.5	3,80 TL
5/16"	M18x1.5-12L	22	20.5	4,50 TL
5/16"	M20x1.5-12S	24	22.8	5,80 TL
3/8"	M16x1.5-10L	19	20.8	4,70 TL
3/8"	M18x1.5-12L	22	20.8	3,60 TL
3/8"	M20x1.5-12S	24	22.8	5,00 TL
3/8"	M22x1.5-15L	27	22.8	7,00 TL
3/8"	M24x1.5-16S	30	22.8	8,80 TL
1/2"	M18x1.5-12L	22	23.3	7,50 TL
1/2"	M20x1.5-12S	24	23.3	7,50 TL
1/2"	M22x1.5-15L	27	23.3	5,65 TL
1/2"	M24x1.5-16S	30	23.3	6,60 TL
1/2"	M26x1.5-18L	32	24.8	15,00 TL
1/2"	M30x2-20S	36	25	15,00 TL
5/8"	M22x1.5-15L	27	32.5	12,40 TL
5/8"	M24x1.5-16S	30	25	11,60 TL
5/8"	M26x1.5-18L	32	25	9,30 TL
5/8"	M30x2-20S	36	33.5	12,40 TL
3/4"	M26x1.5-18L	32		12,40 TL
3/4"	M30x2-20S	36	34.2	12,40 TL
3/4"	M30x2-22L	36	32.2	12,80 TL
3/4"	M36x2-25S	46	36.2	18,00 TL
3/4"	M36x2-28L	41	34.2	20,00 TL
3/4"	M42x2-30S	50	39.7	22,20 TL
1"	M36x2-25S	46	39	17,40 TL
1"	M36x2-28L	41	37	18,00 TL
1"	M42x2-30S	50	40.5	22,20 TL
1"	M45x2-35L	50	35.5	30,00 TL
1" 1/4	M36x2			24,00 TL
1" 1/4	M42x2-30S	50	35	30,00 TL
1" 1/4	M45x2-35L	50	36.5	29,00 TL
1" 1/4	M52x2-38S	60	44.5	42,00 TL
1" 1/4	M52x2-42L	60	46	38,00 TL
1" 1/2	M52x2-38S	60	49	42,00 TL
1" 1/2	M52x2-42L	60	46	42,00 TL

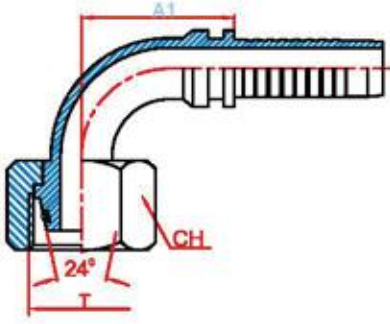
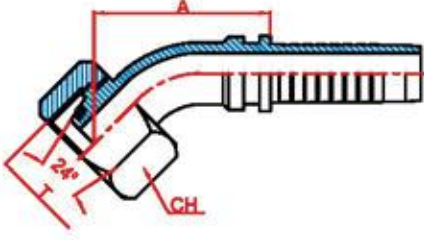
GÜNCEL FİYAT BİLGİSİ İÇİN İLETİŞİME GEÇİNİZ



Metrik (24°) 45° - 90° Hortum Rakorları

Hortum	Anma Ölçüsü	CH	A	A1	Fiyat
3/16"	M12x1.5-6L	14	39.9	22.5	7,00 TL
3/16"	M14x1.5-8L	17	39.9	22.5	7,00 TL
1/4"	M12x1.5-6L	14	40.4	23	8,10 TL
1/4"	M14x1.5-8L	17	40.4	23	6,20 TL
1/4"	M16x1.5-10L	19	47.5	35	6,60 TL
1/4"	M18x1.5-12L	22	47.5	35	8,50 TL
5/16"	M14x1.5-8L	17	40.4	35	8,40 TL
5/16"	M16x1.5-10L	19	47.5	35	6,90 TL
5/16"	M18x1.5-12L	22	47.5	35	7,55 TL
5/16"	M20x1.5-12S	24	47.5	35	10,75 TL
3/8"	M16x1.5-10L	19	47.8	35.3	8,40 TL
3/8"	M18x1.5-12L	22	47.8	35.3	6,40 TL
3/8"	M20x1.5-12S	24	50.2	35.3	7,80 TL
3/8"	M22x1.5-15L	27	50.2	41.8	10,80 TL
3/8"	M24x1.5-16S	30	50.2	42	11,00 TL
1/2"	M18x1.5-12L	22	50.7	42.3	12,40 TL
1/2"	M20x1.5-12S	24	50.7	42.3	12,40 TL
1/2"	M22x1.5-15L	27	50.7	42.3	10,80 TL
1/2"	M24x1.5-16S	30	56.7	42.3	10,20 TL
1/2"	M26x1.5-18L	32	57.4	44	16,40 TL
1/2"	M30x2-20S	36	59	48	24,00 TL
5/8"	M22x1.5-15L	27			24,00 TL
5/8"	M24x1.5-16S	30	58.6	46	21,30 TL
5/8"	M26x1.5-18L	32	58.6	46	16,00 TL
5/8"	M30x2-20S	36	59	50	19,00 TL
3/4"	M26x1.5-18L	32			19,00 TL
3/4"	M30x2-20S	36	73	55	18,60 TL
3/4"	M30x2-22L	36	69.5	53	23,00 TL
3/4"	M36x2-25S	46	71	55	26,30 TL
3/4"	M36x2-28L	41			28,00 TL
3/4"	M42x2-30S	50			28,00 TL
1"	M36x2-25S	46	88	71	30,80 TL
1"	M36x2-28L	41	86.5	70	30,80 TL
1"	M42x2-30S	50	97	70	32,40 TL
1"	M45x2-35L	50	94	71	46,00 TL
1" 1/4	M36x2-28L	41			46,00 TL
1" 1/4	M42x2-30S	50	94.5	75	46,00 TL
1" 1/4	M45x2-35L	50	94.5	76	46,00 TL
1" 1/4	M52x2-38S	60	97	84	65,00 TL
1" 1/4	M52x2-42L	60			65,00 TL
1" 1/2	M52x2-38S	60	114.5	92	65,00 TL
1" 1/2	M52x2-42L	60	114	92	65,00 TL

GÜNCEL FİYAT BİLGİSİ İÇİN İLETİŞİME GEÇİNİZ

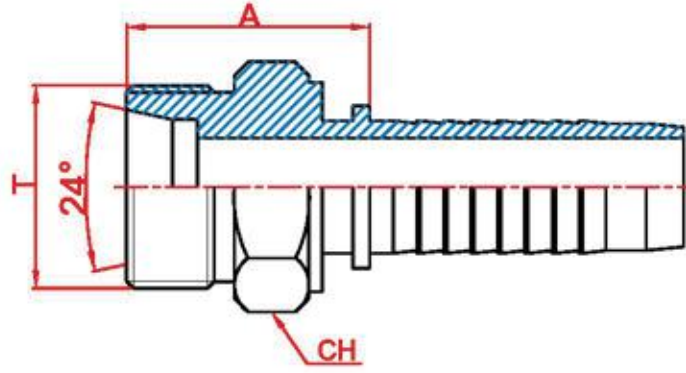

Metrik (24°) Erkek Hortum Rakorları

Hortum	Anma Ölçüsü	CH	A	Fiyat
3/16"	M12x1.5-6L	12	23	3,60 TL
1/4"	M12x1.5-6L	12	24.5	3,60 TL
1/4"	M14x1.5-8L	14	25.5	3,60 TL
1/4"	M16x1.5-10L	17	26	4,25 TL
1/4"	M18x1.5-12L	19	26.5	5,80 TL
5/16"	M14x1.5-8L	14	25	4,20 TL
5/16"	M16x1.5-10L	17	26	3,60 TL
5/16"	M18x1.5-12L	19	26.5	4,30 TL
5/16"	M20x1.5-12S	22	27	5,80 TL
3/8"	M16x1.5-10L	17	24.5	4,50 TL
3/8"	M18x1.5-12L	19	25.5	4,50 TL
3/8"	M20x1.5-12S	22	27	5,50 TL
3/8"	M22x1.5-15L	22	29.5	6,20 TL
1/2"	M18x1.5-12L	19	25.5	6,20 TL
1/2"	M20x1.5-12S	22	28	6,80 TL
1/2"	M22x1.5-15L	22	28	6,20 TL
1/2"	M24x1.5-16S	24	31	6,00 TL
5/8"	M24x1.5-16S	24	30	12,80 TL
5/8"	M26x1.5-18L	27	28	9,30 TL
5/8"	M30x2-20S	32	32.5	11,00 TL
3/4"	M30x2-22L	32	32.5	11,60 TL
3/4"	M30x2-20S	32	34	11,60 TL
3/4"	M36x2-25S	36	36.5	14,00 TL
1"	M36x2-28L	36	36.5	16,30 TL
1"	M36x2-25S	36	37.5	15,50 TL
1"	M42x2-30S	46	39.5	32,40 TL
1"	M45x2-35L	46	39.5	27,00 TL
1" 1/4	M45x2-35L	46	40	27,50 TL
1" 1/4	M52x2-42L	55	44	33,00 TL
1" 1/4	M52x2-38S	55	45.5	36,00 TL
1" 1/2	M52x2-42L	55	44	36,00 TL
1" 1/2	M52x2-38S	55	45.5	36,00 TL

GÜNCEL FİYAT BİLGİSİ İÇİN İLETİŞİME GEÇİNİZ

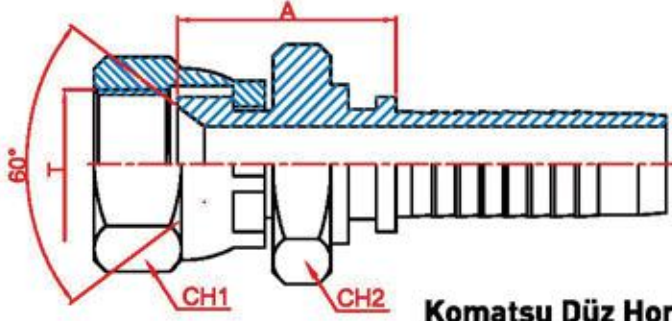

**Komatsu Düz Hortum Rakorları
(Metrik İç Havşa)**

Hortum	Ölçü (T)	CH1	CH2	A	Fiyat
1/4"	M14x1.5	19	14	14.5	5,20 TL
5/16"	M14x1.5	19	14	15.5	6,50 TL
5/16"	M16x1.5	22	17	17	5,10 TL
5/16"	M18x1.5	22	19	17	6,60 TL
3/8"	M16x1.5	22	17	17.3	6,80 TL
3/8"	M18x1.5	22	19	17.3	6,80 TL
1/2"	M22x1.5	27	22	18.3	7,80 TL
1/2"	M24x1.5	30	24	18.3	12,50 TL
5/8"	M24x1.5	30	24	18.5	11,30 TL
3/4"	M30x1.5	36	30	19.5	14,60 TL
1"	M33x1.5	41	36	26.3	20,00 TL
1" 1/4	M36x1.5	46	41	22.3	29,70 TL
1" 1/4	M42x1.5	50	46	25.8	39,20 TL
1" 1/2	M42x1.5	50	46	26.3	41,80 TL

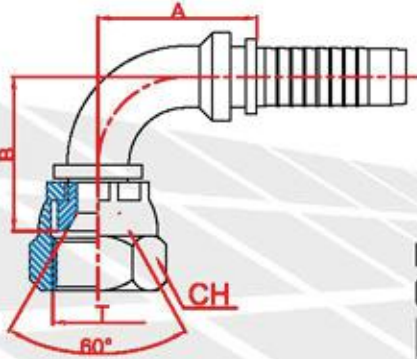

**Komatsu 90° Hortum Rakorları
(Metrik İç Havşa)**

Hortum	Ölçü (T)	CH	A	B	Fiyat
1/4"	M14x1.5	19	23.5	22.5	9,20 TL
5/16"	M14x1.5	19	24.5	25	10,80 TL
5/16"	M16x1.5	22	24.5	25	9,20 TL
5/16"	M18x1.5	22	34.8	33	10,50 TL
3/8"	M16x1.5	22	34.8	29.5	11,30 TL
3/8"	M18x1.5	22	34.8	33	10,50 TL
1/2"	M22x1.5	27	41.8	35.5	13,50 TL
5/8"	M24x1.5	30	57	48	18,40 TL
3/4"	M30x1.5	36	56	50	24,50 TL

GÜNCEL FİYAT BİLGİSİ İÇİN İLETİŞİME GEÇİNİZ

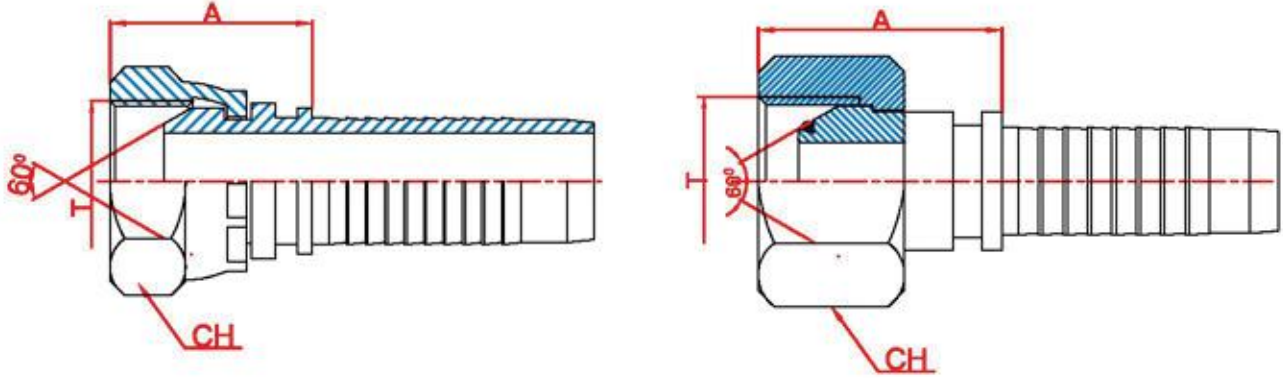

BSP 60° (Dışa Konik) Düz Hortum Rakorları

Hortum	Ölçü (T)	CH	A	Fiyat
3/16"	1/8" - 28	14	17	3,70 TL
1/4"	1/8" - 28	14	17.5	3,70 TL
3/16"	1/4" - 19	19	17	3,70 TL
1/4"	1/4" - 19	19	17.5	3,50 TL
5/16"	1/4" - 19	19	17.5	4,30 TL
3/8"	1/4" - 19	19	17.8	6,00 TL
1/4"	3/8" - 19	22	20.5	4,60 TL
5/16"	3/8" - 19	22	20.5	4,60 TL
3/8"	3/8" - 19	22	20.8	4,00 TL
1/2"	3/8" - 19	22		7,00 TL
1/4"	1/2" - 14	27	22.5	7,40 TL
5/16"	1/2" - 14	27	20.5	6,90 TL
3/8"	1/2" - 14	27	22.8	7,00 TL
1/2"	1/2" - 14	27	23.3	6,40 TL
5/8"	1/2" - 14	27	23.5	15,00 TL
1/2"	5/8" - 14	27	23.3	10,00 TL
5/8"	5/8" - 14	27	23.5	10,60 TL
1/2"	3/4" - 14	32	24.8	12,30 TL
5/8"	3/4" - 14	32	25	12,00 TL
3/4"	3/4" - 14	32	25	10,50 TL
3/4"	1" - 11	41	25.5	18,40 TL
1"	1" - 11	41	26.8	18,00 TL
1"	1" 1/4 - 11	50	30.3	47,00 TL
1" 1/4	1" 1/4 - 11	50	29	29,40 TL
1" 1/4	1" 1/2 - 11	55	34.5	42,00 TL
1" 1/2	1" 1/2 - 11	55	35.3	36,00 TL
1" 1/2	2" - 11	70	36.3	55,40 TL
2"	2" - 11	70	36.3	62,00 TL
2" 1/2	2" 1/2 - 11	82	65	130,00 TL
3"	3" - 11	100	54	142,00 TL

GÜNCEL FİYAT BİLGİSİ İÇİN İLETİŞİME GEÇİNİZ

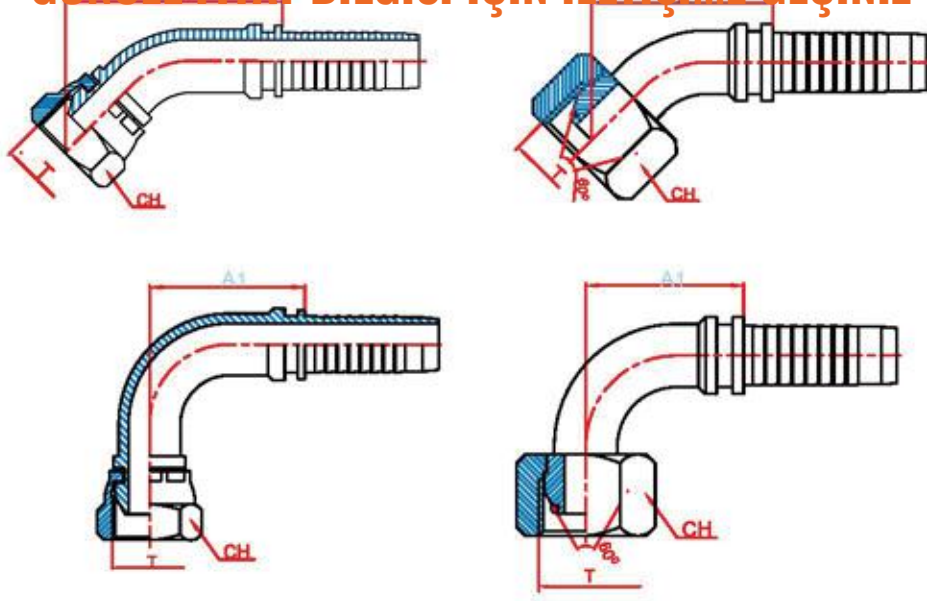

BSP 60° (Dışa Konik) Düz Hortum 45° - 90° Hortum Rakorları

Hortum	Ölçü (T)	CH	A	A1	Fiyat
3/16"	1/8" - 28	14	40	29	7,60 TL
1/4"	1/8" - 28	14	40.5	29.5	7,60 TL
3/16"	1/4" - 19	19	40	29	7,60 TL
1/4"	1/4" - 19	19	40.5	29.5	6,00 TL
5/16"	1/4" - 19	19	40.5	29.5	7,00 TL
3/8"	1/4" - 19	19	40.7	34.8	10,00 TL
1/4"	3/8" - 19	22	47.5	34.5	8,00 TL
5/16"	3/8" - 19	22	47.5	34.5	7,40 TL
3/8"	3/8" - 19	22	47.8	34.8	7,40 TL
1/2"	3/8" - 19	22			13,00 TL
1/4"	1/2" - 14	27	50	37.5	13,00 TL
5/16"	1/2" - 14	27	51	37	13,00 TL
3/8"	1/2" - 14	27	50.2	36.8	13,00 TL
1/2"	1/2" - 14	27	50.7	38.3	10,60 TL
5/8"	1/2" - 14	27	51	42.5	24,00 TL
1/2"	5/8" - 14	27	56.7	41.3	16,00 TL
5/8"	5/8" - 14	27	57	42.5	16,00 TL
1/2"	3/4" - 14	32	62	47.3	21,60 TL
5/8"	3/4" - 14	32	62	48.5	18,60 TL
3/4"	3/4" - 14	32	62	48.5	18,00 TL
3/4"	1" - 11	41	72.4	56	34,00 TL
1"	1" - 11	41	73.7	57.3	29,50 TL
1"	1" 1/4 - 11	50	83.8	63.8	54,00 TL
1" 1/4	1" 1/4 - 11	50	83.8	63.8	50,00 TL
1" 1/4	1" 1/2 - 11	55	103.3	79.8	66,00 TL
1" 1/2	1" 1/2 - 11	55	103.8	79.8	64,20 TL
1" 1/2	2" - 11	70	118	101.3	135,00 TL
2"	2" - 11	70	118	101.5	128,20 TL
2" 1/2	2" 1/2 - 11	82			300,00 TL
3"	3" - 11	100			320,00 TL

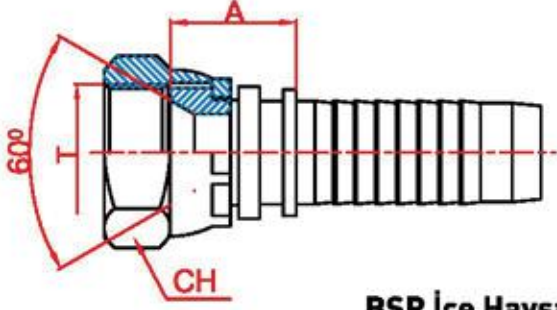
GÜNCEL FİYAT BİLGİSİ İÇİN İLETİŞİME GEÇİNİZ

**BSP İçe Havşa
Düz Hortum Rakorları**

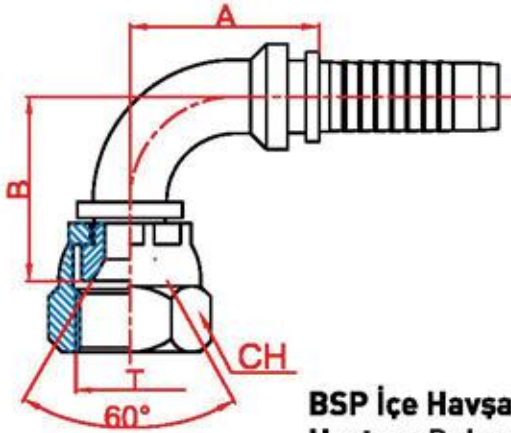
Hortum	Ölçü (T)	CH	A	Fiyat
1/4"	1/4 R	19	17.8	4,60 TL
3/8"	3/8" R	22	18.5	5,40 TL
5/16"	1/2" R	27	20	7,80 TL
3/8"	1/2" R	27	18	7,80 TL
1/2"	1/2" R	27	21	7,80 TL
5/8"	3/4" R	32	23.5	14,00 TL
3/4"	3/4" R	32	24.7	14,00 TL
1"	1" R	41	27	20,00 TL
1" 1/4	1" 1/4 R	50	32.5	35,00 TL
1" 1/2	1" 1/2 R	55	36	43,00 TL
2"	2" R	70	25	79,00 TL

**BSP İçe Havşa 90°
Hortum Rakorları**

Hortum	Ölçü (T)	CH	A	B	Fiyat
1/4"	1/4 R	19	25	25	8,10 TL
3/8"	3/8" R	22	30	31	9,20 TL
5/16"	1/2" R	27	32	33	14,00 TL
3/8"	1/2" R	27	34	33.5	14,00 TL
1/2"	1/2" R	27	36	35	14,00 TL
5/8"	3/4" R	32	46	45	26,20 TL
3/4"	3/4" R	32	55	52	26,20 TL
1"	1" R	41	70	68	40,50 TL
1" 1/4	1" 1/4 R	50	85	83	59,40 TL
1" 1/2	1" 1/2 R	55	101	98	75,00 TL
2"	2" R	70	128	114.5	150,00 TL

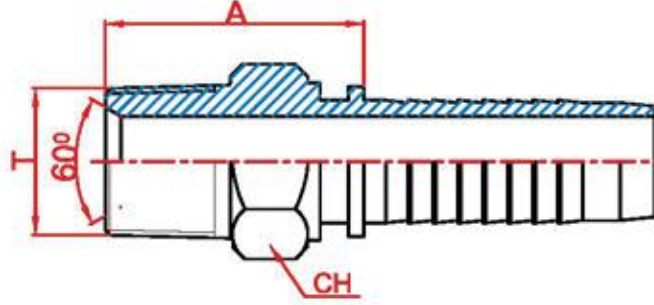
GÜNCEL FİYAT BİLGİSİ İÇİN İLETİŞİME GEÇİNİZ



NPT Konik Erkek Hortum Rakorları

Hortum	Ölçü (T)	CH	A	Fiyat
3/16"	1/8" - 28	12	23	3,40 TL
1/4"	1/8" - 28	12	26.5	3,40 TL
3/16"	1/4" - 19	14	27	3,90 TL
1/4"	1/4" - 19	14	27	3,25 TL
5/16"	1/4" - 19	14	27	4,20 TL
3/8"	1/4" - 19	14	27	4,20 TL
1/4"	3/8" - 19	19	28	4,30 TL
5/16"	3/8" - 19	19	28	4,30 TL
3/8"	3/8" - 19	19	28	4,00 TL
1/2"	3/8" - 19	19	26	8,00 TL
1/4"	1/2" - 14	22	34	5,90 TL
5/16"	1/2" - 14	22	34.5	4,60 TL
3/8"	1/2" - 14	22	34	4,60 TL
1/2"	1/2" - 14	22	31.5	4,80 TL
1/2"	3/4" - 14	30	33.5	10,30 TL
5/8"	3/4" - 14	30	33	10,30 TL
3/4"	3/4" - 14	30	36.5	10,30 TL
3/4"	1" - 11	36	42.5	24,00 TL
1"	1" - 11	36	43.5	15,00 TL
1"	1" 1/4 - 11	46	45.5	28,30 TL
1" 1/4	1" 1/4 - 11	46	46	24,00 TL
1" 1/4	1" 1/2 - 11	50	48	35,00 TL
1" 1/2	1" 1/2 - 11	50	49	28,00 TL
1" 1/2	2" - 11	65	49	66,00 TL
2"	2" - 11	65	41	48,00 TL
2" 1/2	2" 1/2 - 11	70		108,00 TL
3"	3" - 11			132,00 TL

GÜNCEL FİYAT BİLGİSİ İÇİN İLETİŞİME GEÇİNİZ

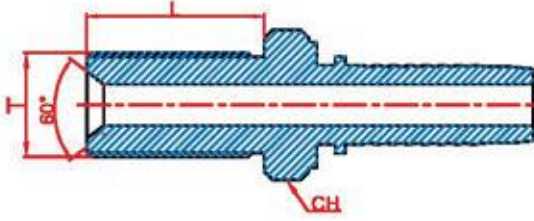

JCB Erkek (Uzun) Hortum Rakorları

Hortum	Ölçü (T)	CH	L	Fiyat
1/2"	1/2" - 14	27	30	10,00 TL
5/8"	5/8" - 14	27	35	10,60 TL
3/4"	3/4" - 14	32	38	14,60 TL

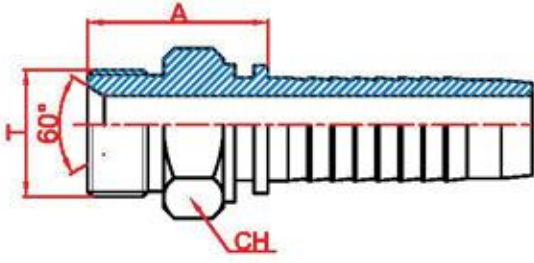

BSP Havşalı Erkek Hortum Rakorları

Hortum	Ölçü (T)	CH	A	Fiyat
1/4"	1/4" - 19	19	27	4,60 TL
3/8"	3/8" - 19	22	29	5,40 TL
1/4"	1/2" - 14	27	30.5	6,30 TL
5/16"	1/2" - 14	27	32.5	6,30 TL
3/8"	1/2" - 14	27	32.5	7,80 TL
1/2"	1/2" - 14	27	33	7,80 TL
3/4"	3/4" - 14	32	36	14,60 TL
1"	1" - 11	41	39.5	19,40 TL

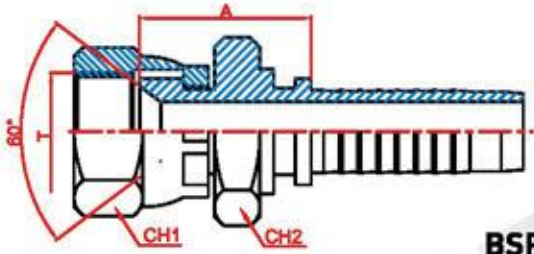

BSP İçe Havşa Düz (A.K.) Hortum Rakorları

Hortum	Ölçü (T)	CH1	CH2	A	Fiyat
1/4"	1/4" - 19	14	14	14.5	7,60 TL
3/8"	3/8" - 19	22	19	17.3	10,50 TL
1/2"	1/2" - 14	27	22	18.3	11,60 TL
3/4"	3/4" - 14	32	27	19.5	18,90 TL
1"	1" - 11	41	36	22.3	29,70 TL

GÜNCEL FİYAT BİLGİSİ İÇİN İLETİŞİME GEÇİNİZ

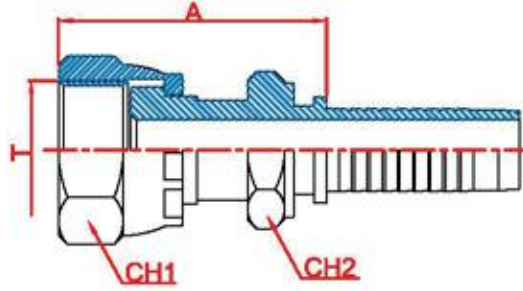

ORFS Düz Hortum Rakorları

Hortum	Ölçü (T)	CH1	CH2	Fiyat
1/4"	9/16" - 18	19	14	5,25 TL
5/16"	9/16" - 18	19	14	5,70 TL
3/8"	9/16" - 18	19	14	6,00 TL
1/4"	11/16" - 16	22	19	5,40 TL
5/16"	11/16" - 16	22	19	6,00 TL
3/8"	11/16" - 16	22	19	6,50 TL
1/2"	11/16" - 16	22	19	8,65 TL
5/16"	13/16" - 16	24	19	8,90 TL
3/8"	13/16" - 16	24	19	7,30 TL
1/2"	13/16" - 16	24	19	8,65 TL
5/8"	13/16" - 16	24	27	13,80 TL
1/2"	1" - 14	30	27	10,80 TL
5/8"	1" - 14	30	27	11,50 TL
3/4"	1" - 14	30	27	18,00 TL
5/8"	1" 3/16 - 12	36	30	13,20 TL
3/4"	1" 3/16 - 12	36	30	14,60 TL
1"	1" 3/16 - 12	36	36	21,60 TL
3/4"	1" 7/16 - 12	41	36	19,40 TL
1"	1" 7/16 - 12	41	36	20,80 TL
1" 1/4	1" 7/16 - 12	41	46	39,20 TL
1"	1" 11/16 - 12	50	46	34,00 TL
1" 1/4	1" 11/16 - 12	50	46	35,50 TL
1" 1/2	1" 11/16 - 12	50	46	56,70 TL
1" 1/4	2" - 12	60	55	67,50 TL
1" 1/2	2" - 12	60	55	75,00TL

GÜNCEL FİYAT BİLGİSİ İÇİN İLETİŞİME GEÇİNİZ

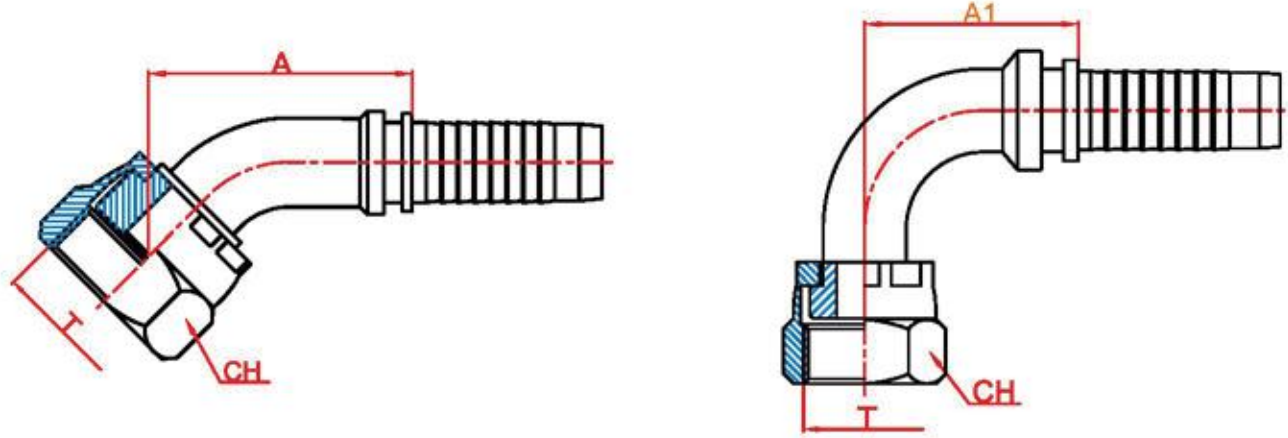

ORFS 45° - 90° Hortum Rakorları

Hortum	Ölçü (T)	CH	A	A1	Fiyat
1/4"	9/16" - 18	19	31.4	31.4	9,30 TL
5/16"	9/16" - 18	19	31.4	31.4	12,00 TL
3/8"	9/16" - 18	19	31.7	31.7	12,00 TL
1/4"	11/16" - 16	22	34.4	34.4	11,00 TL
5/16"	11/16" - 16	22	34.4	34.4	11,50 TL
3/8"	11/16" - 16	22	34.7	34.7	11,50 TL
1/2"	11/16" - 16	22	35.2	35.2	14,60 TL
5/16"	13/16" - 16	24	38.7	38.7	14,90 TL
3/8"	13/16" - 16	24	39	39	14,30 TL
1/2"	13/16" - 16	24	39.5	39.5	15,00 TL
5/8"	13/16" - 16	24	39.7	39.7	23,00 TL
1/2"	1" - 14	30	40.5	40.5	20,00 TL
5/8"	1" - 14	30	40.7	40.7	20,00 TL
3/4"	1" - 14	30	40.7	40.7	33,80 TL
5/8"	1" 3/16 - 12	36	49.8	49.8	23,00 TL
3/4"	1" 3/16 - 12	36	49.8	49.8	29,20 TL
1"	1" 3/16 - 12	36	51	51	37,80 TL
3/4"	1" 7/16 - 12	41	51.4	51.4	30,00 TL
1"	1" 7/16 - 12	41	52.7	52.7	35,00 TL
1" 1/4"	1" 7/16 - 12	41	52.7	52.7	55,00 TL
1"	1" 11/16 - 12	50	69.3	69.3	52,50 TL
1" 1/4"	1" 11/16 - 12	50	69.3	69.3	54,00 TL
1" 1/2"	1" 11/16 - 12	50	69.8	69.8	81,00 TL
1" 1/4"	2" - 12	60	85.3	85.3	81,00 TL
1" 1/2"	2" - 12	60	85.8	85.8	106,00 TL

GÜNCEL FİYAT BİLGİSİ İÇİN İLETİŞİME GEÇİNİZ

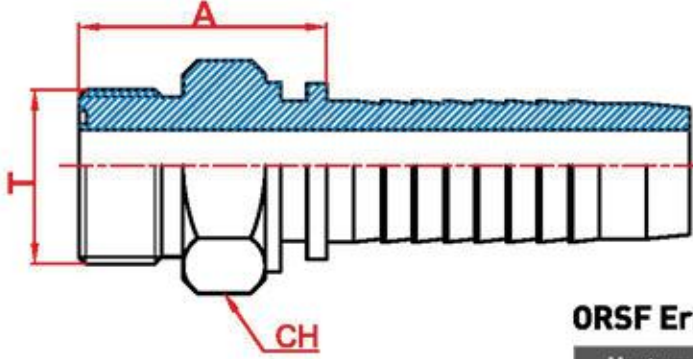

ORSF Erkek Hortum Rakorları

Hortum	Ölçü (T)	CH	A	Fiyat
1/4"	9/16" - 18	17	26.5	5,40 TL
1/4"	11/16" - 16	19	28	5,65 TL
5/16"	9/16" - 18	17	26.5	5,65 TL
5/16"	11/16" - 16	19	28.5	6,00 TL
3/8"	9/16" - 18	17	26.5	6,75 TL
3/8"	11/16" - 16	19	28.8	6,00 TL
3/8"	13/16" - 16	22	29.5	7,00 TL
1/2"	13/16" - 16	22	29.8	7,20 TL
1/2"	1" - 14	27	32.5	10,80 TL
5/8"	1" - 14	27	32.5	10,80 TL
5/8"	1" 3/16 - 12	32	35	13,10 TL
3/4"	1" 3/16 - 12	32	35.5	13,50 TL
3/4"	1" 7/16 - 12	36	40	20,00 TL
1"	1" 7/16 - 12	36	40.8	18,00 TL
1" 1/4"	1" 11/16 - 12	46	41	31,00 TL

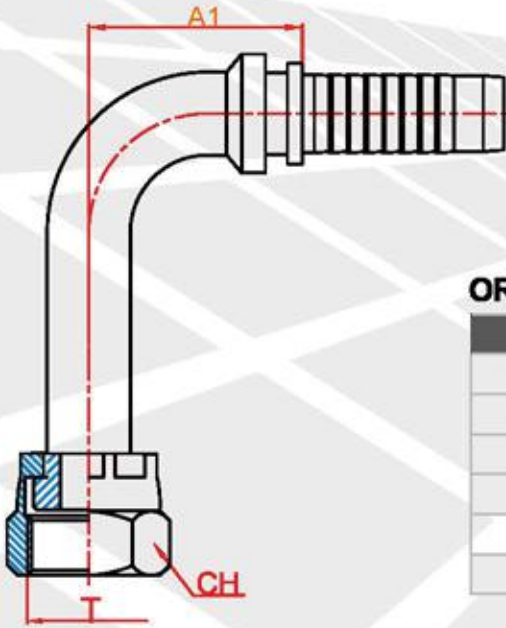

ORFS UZUN 90° Hortum Rakorları

Hortum	Ölçü (T)	CH	A	B	Fiyat
3/8"	11/16" - 16	22	30	65	20,00 TL
1/2"	13/16" - 16	24	36	70	26,80 TL
1/2"	1" - 14	30	36	80	28,00 TL
5/8"	1" - 14	30	36	80	34,50 TL
3/4"	1" 3/16 - 12	36	55	95	37,80 TL
1"	1" 7/16 - 12	41	80	126	52,60 TL

GÜNCEL FİYAT BİLGİSİ İÇİN İLETİŞİME GEÇİNİZ

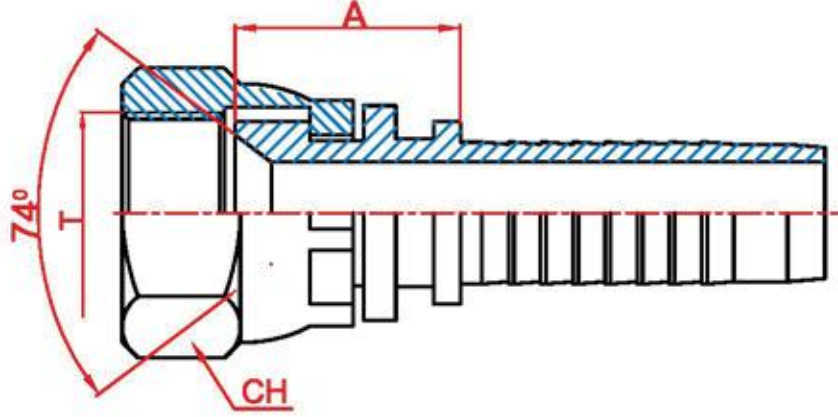

WITHWORTH (J.I.C 74°) Düz Hortum Rakorları

Hortum	Ölçü (T)	CH	A	Fiyat
3/16"	7/16" - 20	15	13.5	3,45 TL
1/4"	7/16" - 20	15	14	3,70 TL
3/16"	1/2" - 20	17	15.5	4,30 TL
1/4"	1/2" - 20	17	16	3,60 TL
5/16"	1/2" - 20	17	16	4,00 TL
1/4"	9/16" - 18	19	15.5	3,90 TL
5/16"	9/16" - 18	19	15.5	3,60 TL
3/8"	9/16" - 18	19	15.8	4,20 TL
5/16"	5/8" - 18	22	16.5	4,20 TL
3/8"	5/8" - 18	22	17.3	4,40 TL
5/16"	3/4" - 16	24	18.8	5,10 TL
3/8"	3/4" - 16	24	18.8	4,50 TL
1/2"	3/4" - 16	24	18.8	4,50 TL
3/8"	7/8" - 14	27	20.3	7,80 TL
1/2"	7/8" - 14	27	20.6	5,40 TL
5/8"	7/8" - 14	27	21	7,00 TL
3/4"	7/8" - 14	27	21.5	12,70 TL
1/2"	1" 1/16 - 12	32	23.5	10,80 TL
5/8"	1" 1/16 - 12	32	23.5	8,60 TL
3/4"	1" 1/16 - 12	32	23.5	10,50 TL
1"	1" 1/16 - 12	32	25.8	22,00 TL
3/4"	1" 5/16 - 12	41	25	18,60 TL
1"	1" 5/16 - 12	41	26.8	16,90 TL
1"	1" 5/8 - 12	50	27.8	40,00 TL
1" 1/4	1" 5/8 - 12	50	27.8	31,00 TL
1" 1/4	1" 7/8 - 12	55	28.8	40,00 TL
1" 1/2	1" 7/8 - 12	55	30.3	38,00 TL
2"	2" 1/2 - 12	70	32	82,00 TL

GÜNCEL FİYAT BİLGİSİ İÇİN İLETİŞİME GEÇİNİZ

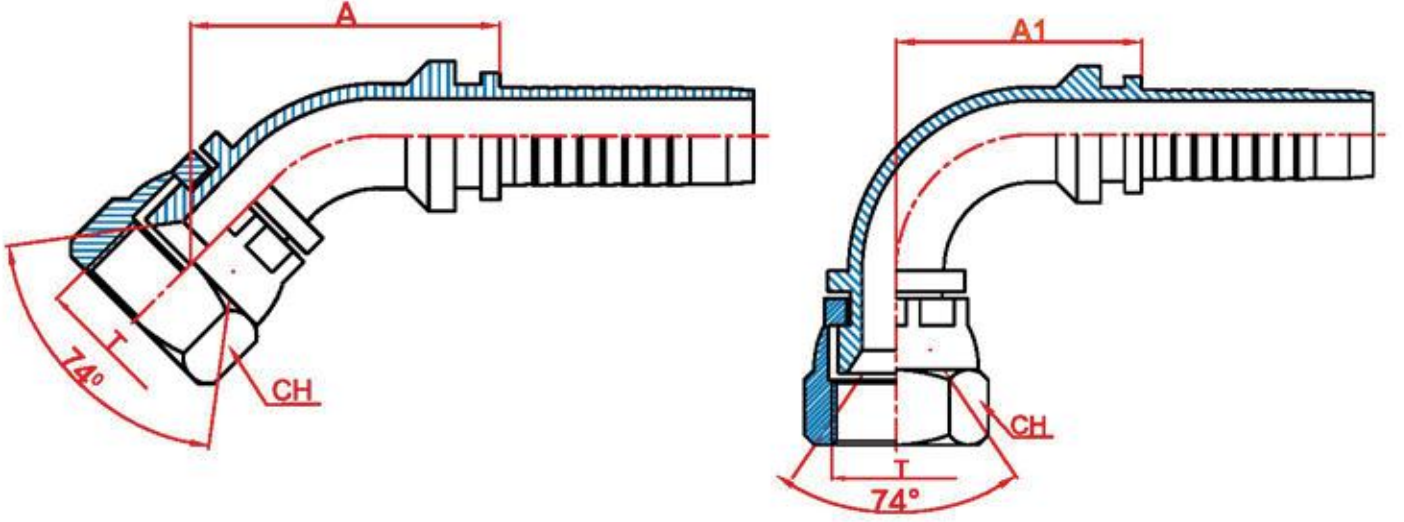

WITHWORTH (J.I.C 74°) 45° - 90° Hortum Rakorları

Hortum	Ölçü [T]	CH	A	A1	Fiyat
3/16"	7/16" - 20	15	30.8	23	6,20 TL
1/4"	7/16" - 20	15	31.3	23.5	6,20 TL
3/16"	1/2" - 20	17	32.2	23	9,50 TL
1/4"	1/2" - 20	17	32.7	23.5	6,60 TL
5/16"	1/2" - 20	17	32.7	24.5	7,10 TL
1/4"	9/16" - 18	19	33	23.5	7,40 TL
5/16"	9/16" - 18	19	33	24.5	7,00 TL
3/8"	9/16" - 18	19	40.2	34.8	6,80 TL
5/16"	5/8" - 18	22	39	34	7,40 TL
3/8"	5/8" - 18	22	42	33	7,40 TL
5/16"	3/4" - 16	24	42.7	34.8	9,00 TL
3/8"	3/4" - 16	24	42.7	34.8	7,60 TL
1/2"	3/4" - 16	24	49.8	41.8	7,60 TL
3/8"	7/8" - 14	27	49	39.3	11,90 TL
1/2"	7/8" - 14	27	51.5	42.3	10,00 TL
5/8"	7/8" - 14	27	60.7	57	13,30 TL
3/4"	7/8" - 14	27	60.7	57	25,00 TL
1/2"	1" 1/16 - 12	32	62	56	23,00 TL
5/8"	1" 1/16 - 12	32	62	56	17,00 TL
3/4"	1" 1/16 - 12	32	62	56	17,60 TL
1"	1" 1/16 - 12	32	80	70	47,00 TL
3/4"	1" 5/16 - 12	41	65	56	34,00 TL
1"	1" 5/16 - 12	41	81.5	76.8	30,00 TL
1"	1" 5/8 - 12	50	83	77.8	50,00 TL
1" 1/4	1" 5/8 - 12	50	84.4	77.8	50,00 TL
1" 1/4	1" 7/8 - 12	55	92	77.8	75,00 TL
1" 1/2	1" 7/8 - 12	55	117	101	65,00 TL
2"	2" 1/2 - 12	70	140	123	155,00 TL

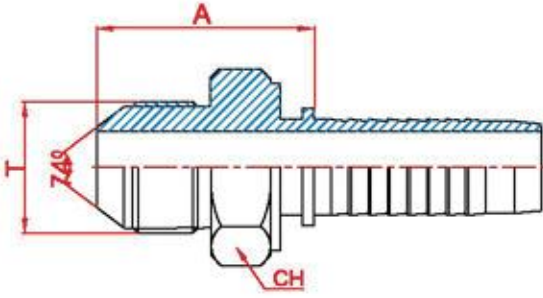
GÜNCEL FİYAT BİLGİSİ İÇİN İLETİŞİME GEÇİNİZ

WITHWORTH (J.I.C 74°) Erkek Hortum Rakorları

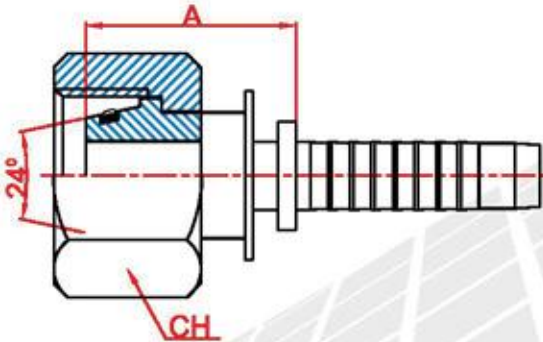
Hortum	Ölçü (T)	CH	A	Fiyat
3/16"	7/16" - 20	12	25	3,80 TL
1/4"	7/16" - 20	12	27.5	3,80 TL
3/16"	1/2" - 20	14	27.5	6,80 TL
1/4"	1/2" - 20	14	29	4,00 TL
5/16"	1/2" - 20	14	28	4,30 TL
1/4"	9/16" - 18	17	29	4,30 TL
5/16"	9/16" - 18	17	29	4,30 TL
3/8"	9/16" - 18	17	28.5	4,80 TL
5/16"	5/8" - 18	17	29	4,80 TL
3/8"	5/8" - 18	17	29	5,00 TL
3/8"	3/4" - 16	19	33	4,80 TL
1/2"	3/4" - 16	19	33.5	5,50 TL
3/8"	7/8" - 14	22	35	7,70 TL
1/2"	7/8" - 14	22	36.5	5,50 TL
5/8"	7/8" - 14	22	36	7,80 TL
1/2"	1" 1/16 - 12	27	40	15,50 TL
5/8"	1" 1/16 - 12	27	39.5	10,00 TL
3/4"	1" 1/16 - 12	27	40.5	10,00 TL
1"	1" 1/16 - 12	32	42.5	21,60 TL
3/4"	1" 5/16 - 12	36	43	21,60 TL
1"	1" 5/16 - 12	36	45	17,00 TL
1" 1/4"	1" 5/8 - 12	46	48	31,00 TL
1" 1/2"	1" 7/8 - 12	50	54	46,50 TL



Kırıcı Hortum Rakorları

Hortum	Diş Ölçüsü	Fiyat
1"	M36x2 - 25S	20,00 TL
1"	M42x2 - 30S	25,00 TL
1"	M45x2 - 35L	27,00 TL
1" 1/4"	M42x2 - 30S	26,00 TL
1" 1/4"	M45x2 - 35L	27,00 TL
1"	G 1" - 11	21,00 TL
1"	1" 7/16 - 12	21,00 TL

GÜNCEL FİYAT BİLGİSİ İÇİN İLETİŞİME GEÇİNİZ

Flanşlı (SAE 3000) Düz Hortum Rakorları

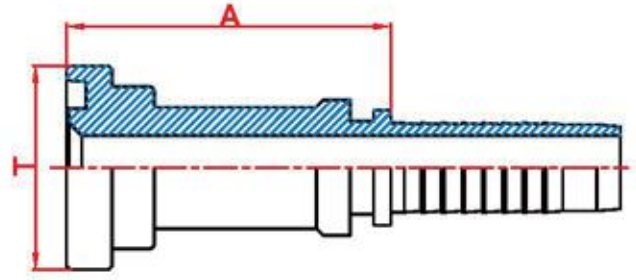
Hortum	Flanş (T)	A	Fiyat
1/2"	30.2	46	12,00 TL
1/2"	38.1	53.6	15,00 TL
5/8"	38.1	56	16,20 TL
3/4"	38.1	54	16,20 TL
3/4"	44.5	59.5	22,00 TL
1"	38.1	53	19,00 TL
1"	44.5	58.8	21,00 TL
1"	50.8	64.8	29,00 TL
1"	60.3	72.5	45,00 TL
1" 1/4	44.5	63.5	34,00 TL
1" 1/4	50.8	66.8	29,00 TL
1" 1/4	60.3	73.8	48,00 TL
1" 1/2	60.3	74.3	55,00 TL
1" 1/2	71.4	78.5	81,00 TL
2"	71.4	79.5	81,00 TL
2" 1/2	84.12	79.5	140,00 TL
3"	101.60		150,00 TL
3" 1/2	114.30		202,00 TL
4"	127		250,00 TL



Flanşlı (SAE 6000) Düz Hortum Rakorları

Hortum	Flanş (T)	A	Fiyat
1/2"	31.7	57.5	12,20 TL
1/2"	41.3	59	21,60 TL
5/8"	31.7	58	18,40 TL
5/8"	41.3	59.5	19,60 TL
3/4"	41.3	59.5	19,60 TL
3/4"	47.6	67.5	26,50 TL
1"	41.3	66.8	21,60 TL
1"	47.6	68.5	30,40 TL
1"	54	77	33,80 TL
1" 1/4	47.6	74.8	37,80 TL
1" 1/4	54	77.3	43,20 TL
1" 1/4	63.5	86.8	58,00 TL
1" 1/2	63.5	87.3	62,00 TL
2"	79.4	94.5	105,00 TL

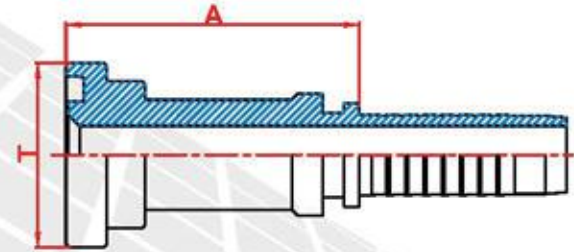

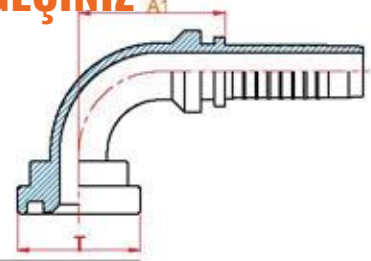
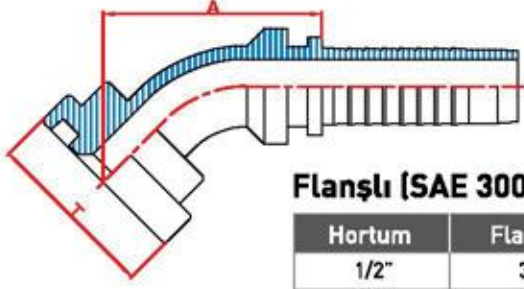
GÜNCEL FİYAT BİLGİSİ İÇİN İLETİŞİME GEÇİNİZ

Flanşlı (SAE 3000) 45° - 90° Hortum Rakorları

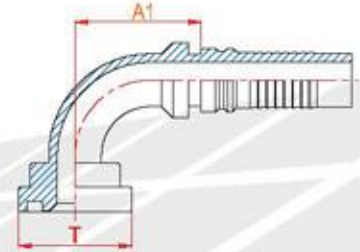
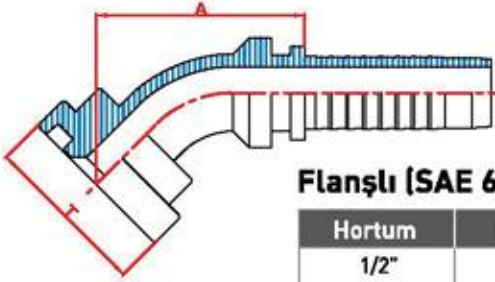
Hortum	Flanş (T)	A	A1	Fiyat
1/2"	30.2	40.5	38.5	18,90 TL
1/2"	38.1	51	47.3	22,30 TL
5/8"	38.1	52	47.5	31,00 TL
3/4"	38.1	63.2	47.5	25,70 TL
3/4"	44.5	63.2	58	33,80 TL
1"	38.1	63.5	59.3	40,50 TL
1"	44.5	79.6	59	44,90 TL
1"	50.8	79.6	65.8	50,00 TL
1"	60.3	84.5	81	78,00 TL
1" 1/4	44.5	80	65.8	78,00 TL
1" 1/4	50.8	84	65.8	58,00 TL
1" 1/4	60.3	86.5	81.8	75,60 TL
1" 1/2	60.3	87	82.3	75,60 TL
1" 1/2	71.4	101.5	103	124,00 TL
2"	71.4	101.5	103.5	148,00 TL
2" 1/2	84.12	101.5		230,00 TL
3"	101.60			283,00 TL
3" 1/2	114.30			324,00 TL
4"	127			385,00 TL

Flanşlı (SAE 6000) 45° - 90° Hortum Rakorları

Hortum	Flanş (T)	A	A1	Fiyat
1/2"	31.7	43	38	21,60 TL
1/2"	41.3	54	47.3	27,00 TL
5/8"	31.7	44	39	32,40 TL
5/8"	41.3	54.5	47.5	32,40 TL
3/4"	41.3	54.5	47.5	29,80 TL
3/4"	47.6	66	58	37,80 TL
1"	41.3	65.8	48.8	34,80 TL
1"	47.6	67.3	59.3	47,00 TL
1"	54	76	65.8	58,00 TL
1" 1/4	47.6	68	65.8	74,00 TL
1" 1/4	54	76	65.8	74,00 TL
1" 1/4	63.5	96.3	81.8	92,00 TL
1" 1/2	63.5	96.8	82.3	100,00 TL
2"	79.4	109	103.5	223,00 TL

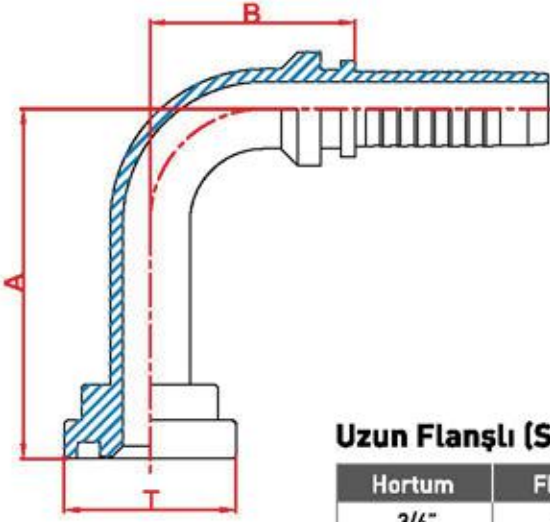
GÜNCEL FİYAT BİLGİSİ İÇİN İLETİŞİME GEÇİNİZ



Uzun Flanşlı (SAE 3000) 90° Hortum Rakorları

Hortum	Flanş (T)	B	10 cm	12 - 13 cm	15 cm
3/4"	38.1	67.5	55,00 TL	58,00 TL	60,90 TL
3/4"	44.5	70	63,00 TL	66,00 TL	69,30 TL
1"	38.1	60	68,00 TL	71,50 TL	75,00 TL
1"	44.5	71.8	73,00 TL	77,00 TL	81,00 TL
1"	50.8	71	90,00 TL	94,00 TL	98,00 TL
1" 1/4	50.8	97.8	115,00 TL	121,00 TL	127,00 TL
1" 1/2	60.3	120.3	158,00 TL	166,00 TL	174,00 TL

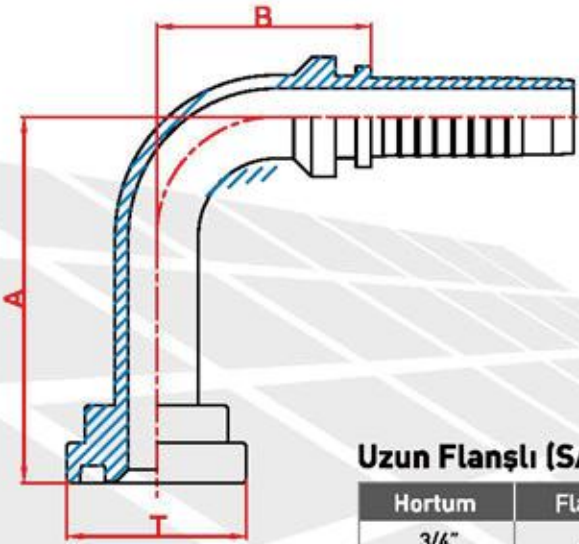

Uzun Flanşlı (SAE 6000) 90° Hortum Rakorları

Hortum	Flanş (T)	B	10 cm	12 - 13 cm	15 cm
3/4"	41.3	67.5	60,00 TL	63,00 TL	66,15 TL
3/4"	47.6		62,00 TL	65,00 TL	68,25 TL
1"	41.3	71.8	63,00 TL	66,00 TL	69,30 TL
1"	47.6	80	82,00 TL	86,00 TL	90,30 TL
1"	54	80	96,00 TL	101,00 TL	115,00 TL
1" 1/4	54	97.8	121,00 TL	127,00 TL	145,00 TL

GÜNCEL FİYAT BİLGİSİ İÇİN İLETİŞİME GEÇİNİZ

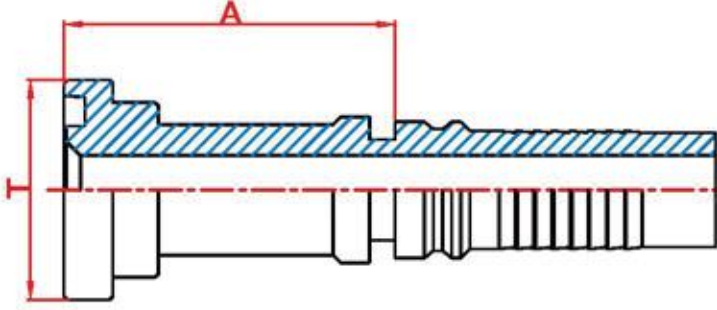

Flanşlı (SAE 6000) Düz Sıyrmalı Hortum Rakorları

Hortum	Ölçü (T)	A	Fiyat
1" 1/4	54	74	54,00 TL
1" 1/4	63.5	60	75,00 TL
1" 1/2	63.5	59.5	81,00 TL
2"	79.4	90	135,00 TL

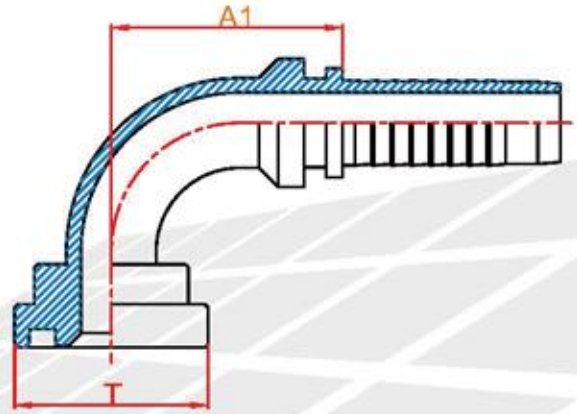
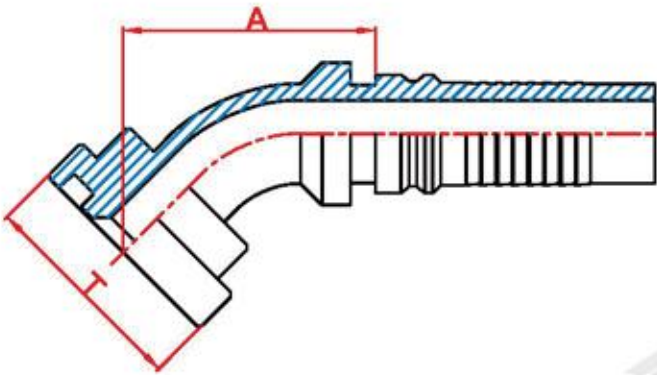

Flanşlı (SAE 6000) 45°- 90° Sıyrmalı Hortum Rakorları

Hortum	Ölçü (T)	A	A1	Fiyat
1" 1/4	54	74	62	94,00 TL
1" 1/4	63.5	93	79	121,00 TL
1" 1/2	63.5	93.5	78.5	130,00 TL
2"	79.4	105	99.5	290,00 TL

GÜNCEL FİYAT BİLGİSİ İÇİN İLETİŞİME GEÇİNİZ

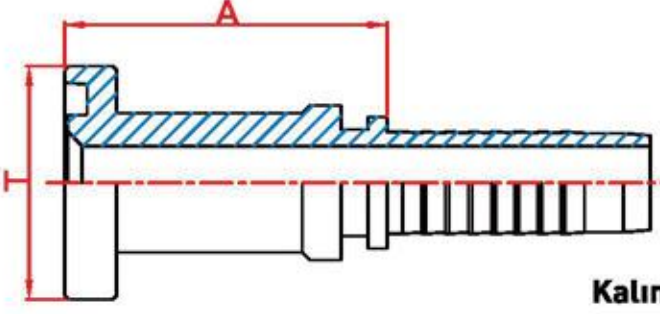

Kalın Flanşlı (SAE 6000) Düz Hortum Rakorları

Hortum	Ölçü (T)	A	Fiyat
3/4"	41.3	49.5	21,60 TL
1"	47.6	57	31,00 TL
1"	54	62.3	35,00 TL
1"	63.5	66.5	56,60 TL
1" 1/4	47.6	63.3	46,00 TL
1" 1/4	54	63	43,20 TL
1" 1/4	63.5	69.3	56,70 TL
1" 1/2	63.5	69.8	63,50 TL

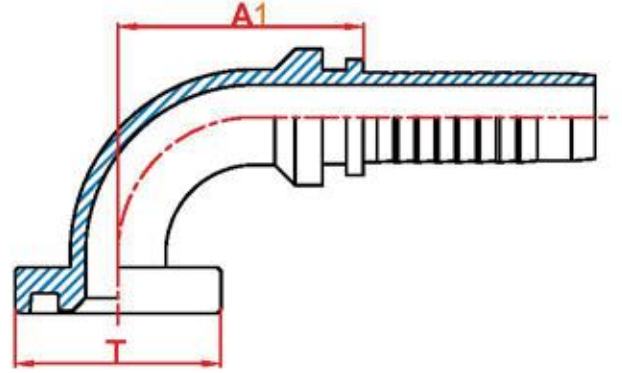
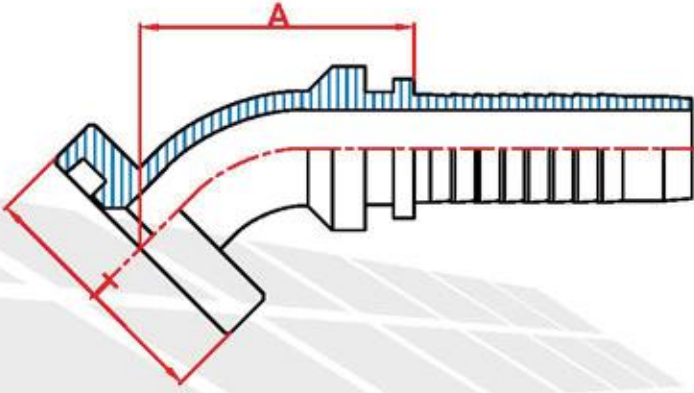

Kalın Flanşlı (SAE 6000) 45°- 90° Rakorlar

Hortum	Ölçü (T)	A	A1	Fiyat
3/4"	41.3	46.5	39.5	29,80 TL
1"	47.6	56.5	48	48,60 TL
1"	54	61.5	52	56,80 TL
1"	63.5	81	64.5	100,00 TL
1" 1/4	47.6	61	51	74,00 TL
1" 1/4	54	62	53	74,00 TL
1" 1/4	63.5	81.5	64.5	100,00 TL
1" 1/2	63.5	81.8	65	105,00 TL

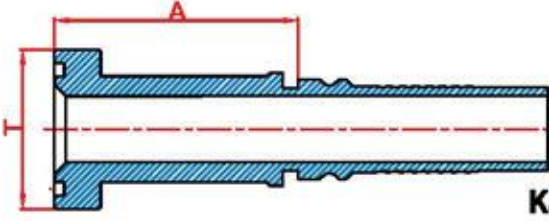
GÜNCEL FİYAT BİLGİSİ İÇİN İLETİŞİME GEÇİNİZ

Kalın Flanşlı (SAE 6000) Sıyrılmalı Düz Hortum Rakorları

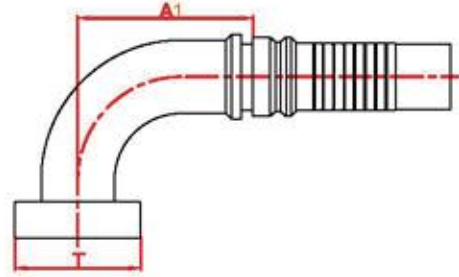
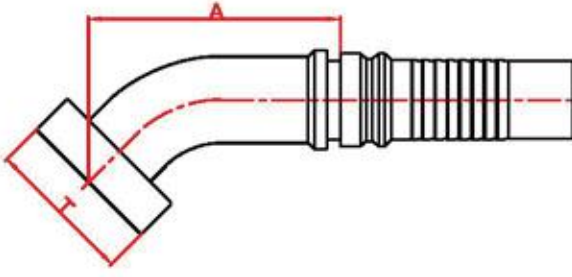
Hortum	Ölçü (T)	A	Fiyat
1" 1/4	54	60	54,00 TL
1" 1/4	63.5	62.3	74,00 TL
1" 1/2	63.5	65.8	85,00 TL

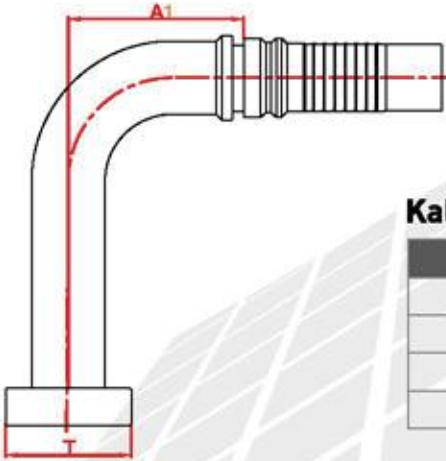

Kalın Flanşlı (SAE 6000) 45°- 90° Sıyrılmalı Hortum Rakorları

Hortum	Ölçü (T)	A	A1	Fiyat
1" 1/4	54	58	49	97,00 TL
1" 1/4	63.5	77.5	60.5	118,00 TL
1" 1/2	63.5	77.8	61	130,00 TL

Kalın Flanşlı Uzun 90° Sıyrılmalı Hortum Rakorları

Hortum	Ölçü (T)	10 cm	12 - 13 cm	15 cm	18 cm
3/4"	41.3	-	-	-	85,00 TL
1"	47.6	-	-	-	115,00 TL
1"	54	-	-	-	135,00 TL
1" 1/4	54	135,00 TL	140,00 TL	155 TL	180,00 TL

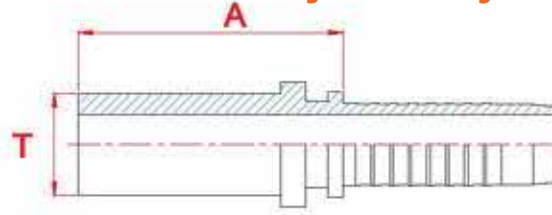
GÜNCEL FİYAT BİLGİSİ İÇİN İLETİŞİME GEÇİNİZ



Boru Uçlu Düz Hortum Rakorları

Hortum	Ölçü (T)	A	Fiyat
3/16"	6	26	4,40 TL
1/4"	6	29	4,40 TL
1/4"	8	29	4,40 TL
1/4"	10	31.5	4,40 TL
5/16"	8	26	4,40 TL
5/16"	10	29	4,40 TL
5/16"	12	32	4,80 TL
3/8"	8	30	4,80 TL
3/8"	10	32	4,80 TL
3/8"	12	32	4,80 TL
1/2"	12	35	6,60 TL
1/2"	16	38	6,60 TL

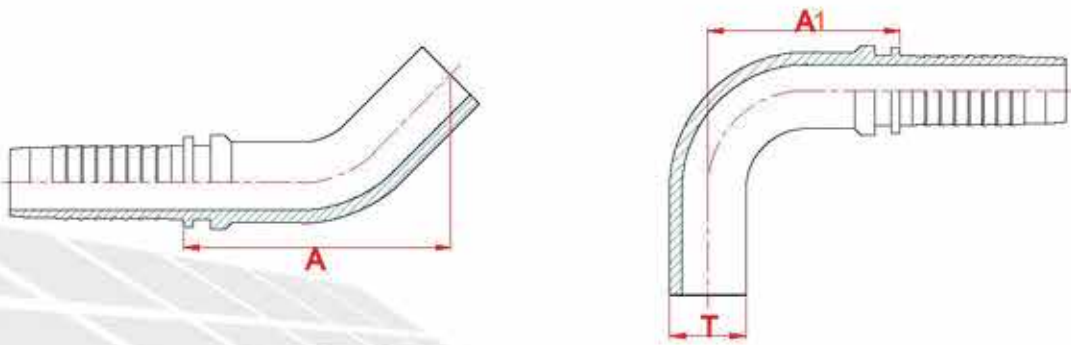

Boru Uçlu 45°- 90° Sıyırmalı Hortum Rakorları

Hortum	Ölçü (T)	A	A1	Fiyat
3/16"	6	23	39	8,40 TL
1/4"	6	24	40	8,40 TL
1/4"	8	27	44	8,40 TL
1/4"	10	30	45	8,40 TL
5/16"	8	31	44	8,40 TL
5/16"	10	30	45	8,40 TL
5/16"	12	33	48	9,20 TL
3/8"	8	30	47	9,20 TL
3/8"	10	31	46	9,20 TL
3/8"	12	34	49	9,20 TL
1/2"	12	36	53	13,40 TL
1/2"	16	40	57	13,40 TL

GÜNCEL FİYAT BİLGİSİ İÇİN İLETİŞİME GEÇİNİZ

Presli Ara Ek Rakorlar

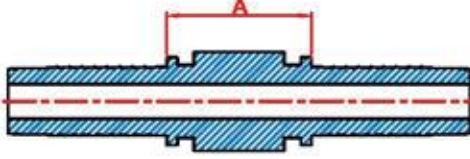

Ebat	A	Fiyat
3/16"	13	4,00 TL
1/4"	14	4,30 TL
5/16"	14	5,00 TL
3/8"	14.6	5,20 TL
1/2"	20.6	6,30 TL
5/8"	21	10,00 TL
3/4"	21	12,70 TL
1"	23.6	20,00 TL
1" 1/4	28.6	29,80 TL
1" 1/2	29.6	40,50 TL
2"	30	67,50 TL

Yıkama Makinası Hortum Rakorları

Hortum	Anma Ölçüsü	CH	Ölçü (T)	Fiyat
1/4"	M22x1.5	27	20	12,20 TL
5/16"	M22x1.5	27	20	12,20 TL
3/8"	M22x1.5	27	20	12,20 TL

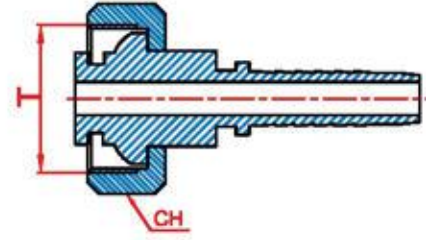

Kaynaklı Presli Düz İçler

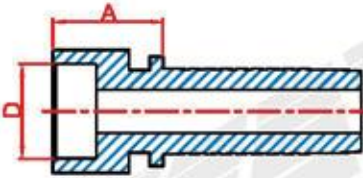

Ebat	D	A	Fiyat
3/16"	6	12	3,00 TL
1/4"	8	12.5	3,00 TL
5/16"	12	14.5	3,60 TL
3/8"	12	14.8	4,00 TL
1/2"	16	17.3	5,60 TL
5/8"	20	17.5	10,00 TL
3/4"	22	17.5	11,00 TL
1"	28	21.8	18,50 TL
1" 1/4	35	23.8	28,50 TL
1" 1/2	38	25.3	35,50 TL
2"	48	31.8	50,00 TL
2" 1/2	60	40.2	85,00 TL
3"	70	47.3	110,00 TL

GÜNCEL FİYAT BİLGİSİ İÇİN İLETİŞİME GEÇİNİZ

Gres Hortum Rakorlar

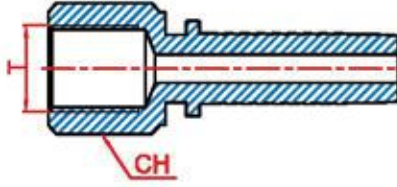

Hortum	CH	T	Fiyat
3/16"	14	1/8" - Sabit Dişi	5,40 TL
1/4"	14	1/8" - Sabit Dişi	5,40 TL
5/16"	14	1/8" - Sabit Dişi	6,00 TL

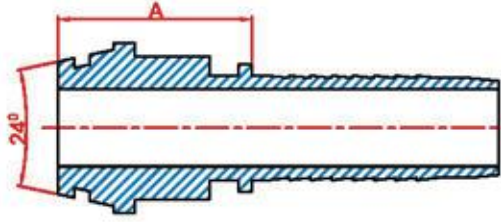

Metrik Presli Düz İçler

Hortum	A	Fiyat
3/16"	17	2,70 TL
1/4"	20.5	2,70 TL
5/16"	20.5	3,00 TL
3/8"	22.8	3,20 TL
1/2"	23.3	4,90 TL
5/8"	33.5	9,50 TL
3/4"	36.2	10,00 TL
1"	40.5	16,80 TL
1" 1/4	44.5	25,20 TL
1" 1/2	49	31,60 TL

Metrik Civatalar

Ölçü	CH	L	Fiyat
M8x1.25	12	20	3,50 TL
M10x1	14	25	4,00 TL
M12x1.5	17	30	4,60 TL
M14x1.5	19	33	4,90 TL
M16x1.5	22	36	6,80 TL
M18x1.5	24	40	8,20 TL

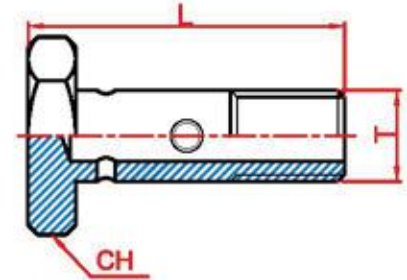

BSP Civatalar

Ölçü	CH	L	Fiyat
1/8" - 28	14	25	4,00 TL
1/4" - 19	19	30	4,60 TL
3/8" - 19	22	38	6,20 TL
1/2" - 14	27	46	8,20 TL

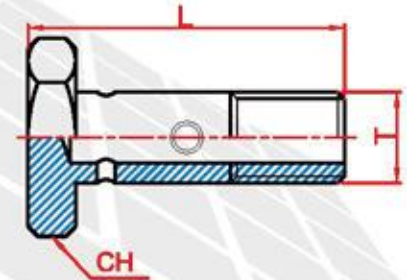

GÜNCEL FİYAT BİLGİSİ İÇİN İLETİŞİME GEÇİNİZ

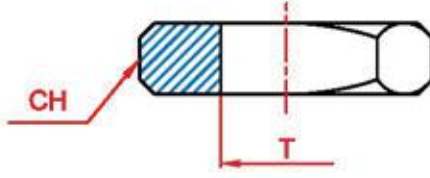

Metrik Kontra Somunlar

T	CH	Fiyat
M12x1.5	17	1,60 TL
M14x1.5	19	1,60 TL
M16x1.5	22	1,60 TL
M18x1.5	22	1,80 TL
M20x1.5	24	2,20 TL
M22x1.5	27	2,40 TL
M24x1.5	30	2,60 TL
M26x1.5	32	3,40 TL
M30x2	36	4,40 TL
M36x2	46	6,00 TL
M42x2	50	8,20 TL
M45x2	55	10,60 TL
M52x2	60	13,20 TL

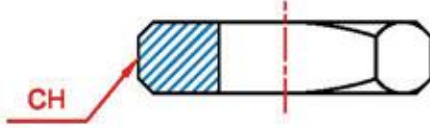

BSP Kontra Somunlar

T	CH	Fiyat
1/8" - 28	14	1,60 TL
1/4" - 19	17	1,60 TL
3/8" - 19	22	1,60 TL
1/2" - 14	27	1,90 TL
3/4" - 14	32	2,40 TL
1" - 11	41	3,00 TL
1" 1/4 - 11	50	4,60 TL
1" 1/2 - 11	55	8,80 TL

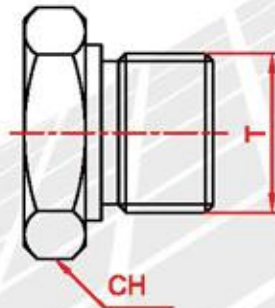

Metrik Tapalar

T	CH	Fiyat
M12x1.5	17	2,30 TL
M14x1.5	19	2,40 TL
M16x1.5	22	2,50 TL
M18x1.5	24	2,90 TL
M20x1.5	24	3,40 TL
M22x1.5	27	4,10 TL
M24x1.5	30	5,10 TL
M30x2	36	7,20 TL

GÜNCEL FİYAT BİLGİSİ İÇİN İLETİŞİME GEÇİNİZ

BSP Tapalar

T	CH	Fiyat
1/8" - 28	14	1,80 TL
1/4" - 19	19	1,90 TL
3/8" - 19	22	2,30 TL
1/2" - 14	27	3,20 TL
3/4" - 14	32	5,00 TL
1" - 11	41	9,20 TL
1" 1/4 - 11	50	13,50 TL
1" 1/2 - 11	55	18,40 TL

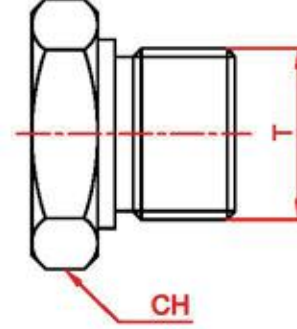

Metrik Alyan Başlı Tapalar

T	Fiyat
M10x1	2,70 TL
M12x1.5	2,60 TL
M14x1.5	3,10 TL
M16x1.5	3,50 TL
M18x1.5	3,90 TL
M20x1.5	5,10 TL
M22x1.5	5,70 TL

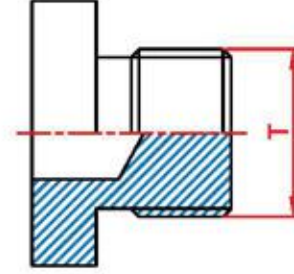

BSP Alyan Başlı Tapalar (Oringli)

T	Fiyat
1/8" - 28	2,00 TL
1/4" - 19	2,40 TL
3/8" - 19	2,80 TL
1/2" - 14	3,70 TL
3/4" - 14	4,40 TL
1" - 11	7,40 TL
1" 1/4 - 11	13,00 TL
1" 1/2 - 11	18,60 TL

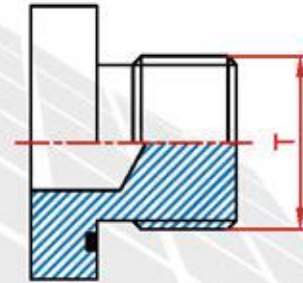

GÜNCEL FİYAT BİLGİSİ İÇİN İLETİŞİME GEÇİNİZ

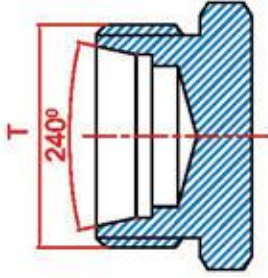

Metrik Erkek Kör Tapalar

L Tipi	T		Anahtar Ölçüsü (mm)	Fiyat
	M12x1.5	6L	12	3,00 TL
	M14x1.5	8L	14	3,00 TL
	M16x1.5	10L	17	2,70 TL
	M18x1.5	12L	19	2,70 TL
	M22x1.5	15L	24	4,40 TL
	M26x1.5	18L	27	6,20 TL
	M30x2	22L	32	8,80 TL
	M36x2	28L	41	12,40 TL
	M45x2	35L	46	21,00 TL
M52x2	42L	55	32,50 TL	

S Tipi	T		Anahtar Ölçüsü (mm)	Fiyat
	M20x1.5	12S	22	3,90 TL
	M24x1.5	16S	27	4,90 TL
	M30x2	20S	32	8,00 TL
	M36x2	25S	41	12,00 TL
	M42x2	30S	46	20,00 TL
	M52x2	38S	55	33,00 TL

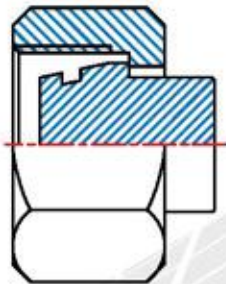

Metrik Somunlu Tapalar

L Tipi	T		Anahtar Ölçüsü (mm)	Fiyat
	M12x1.5	6L	14	3,60 TL
	M14x1.5	8L	17	3,60 TL
	M16x1.5	10L	19	4,20 TL
	M18x1.5	12L	22	4,20 TL
	M22x1.5	15L	27	7,20 TL
	M26x1.5	18L	32	10,30 TL
	M30x2	22L	36	14,80 TL
	M36x2	28L	41	21,00 TL
	M45x2	35L	50	35,00 TL
M52x2	42L	60	54,00 TL	

S Tipi	T		Anahtar Ölçüsü (mm)	Fiyat
	M20x1.5	12S	24	6,00 TL
	M24x1.5	16S	30	7,80 TL
	M30x2	20S	36	14,00 TL
	M36x2	25S	46	23,00 TL
	M42x2	30S	50	31,00 TL
M52x2	38S	60	55,00 TL	

GÜNCEL FİYAT BİLGİSİ İÇİN İLETİŞİME GEÇİNİZ

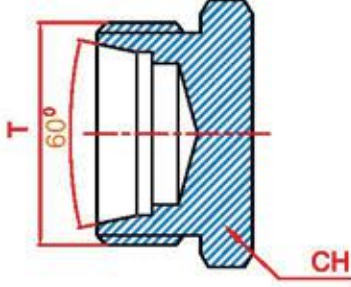

BSP Erkek Havşalı Tapalar

T	CH	Fiyat
1/4" - 19	19	2,70 TL
3/8" - 19	22	2,70 TL
1/2" - 14	27	4,60 TL
3/4" - 14	32	7,30 TL
1" - 11	41	11,90 TL
1" 1/4 - 11	50	23,50 TL

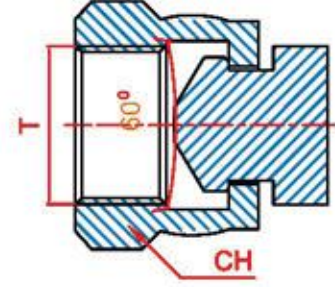

BSP Dişi Tapalar

T	CH	Fiyat
1/4" - 19	19	3,80 TL
3/8" - 19	22	4,00 TL
1/2" - 14	27	7,20 TL
3/4" - 14	32	12,80 TL
1" - 11	41	18,40 TL
1" 1/4 - 11	50	38,00 TL

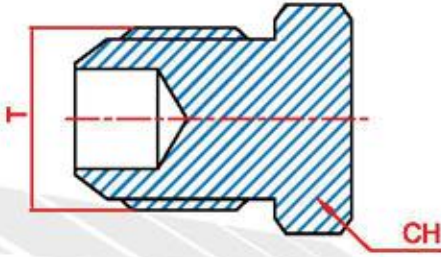

UNF Erkek Kör Tapalar

T	CH	Fiyat
7/16"-20	14	2,60 TL
1/2"-20	14	2,70 TL
9/16"-18	17	3,00 TL
5/8"-18	17	3,50 TL
3/4"-16	19	3,60 TL
7/8"-14	24	5,50 TL
1"1/16-12	27	8,10 TL
1"5/16-12	36	12,60 TL
1"5/8-12	46	25,00 TL
1"7/8-12	50	29,00 TL

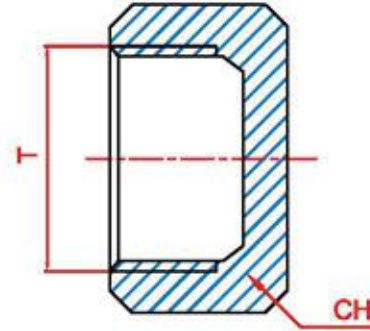

UNF Kör Somun

T	CH	Fiyat
7/16"-20	14	2,60 TL
1/2"-20	17	2,70 TL
9/16"-18	19	3,00 TL
5/8"-18	21	3,40 TL
3/4"-16	24	3,80 TL
7/8"-14	27	5,50 TL
1"1/16-12	32	8,10 TL
1"5/16-12	41	13,80 TL
1"5/8-12	50	19,80 TL
1"7/8-12	55	40,00 TL

GÜNCEL FİYAT BİLGİSİ İÇİN İLETİŞİME GEÇİNİZ

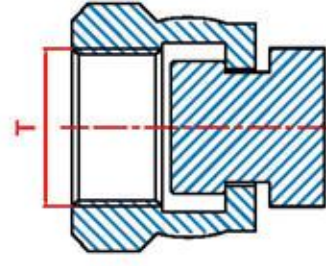
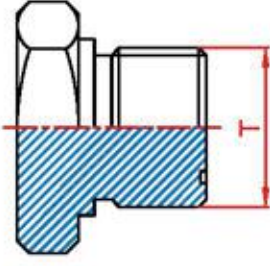

ORFS Erkek Tapalar

T	Anahtar Ölçüsü (mm)	Fiyat
9/16-18	17	3,80 TL
11/16-16	19	4,30 TL
13/16-16	22	5,60 TL
1" - 14	27	8,20 TL
1" 3/16-12	32	10,50 TL
1" 7/16-12	41	13,60 TL
1" 11/16-12	46	22,00 TL

ORFS Somunlu Tapalar

Dış Ölçüsü	Anahtar Ölçüsü (mm)	Fiyat
9/16-18	19	5,60 TL
11/16-16	22	6,60 TL
13/16-16	24	7,60 TL
1" - 14	30	12,00 TL
1" 3/16-12	36	13,60 TL
1" 7/16-12	41	20,00 TL
1" 11/16-12	50	26,00 TL

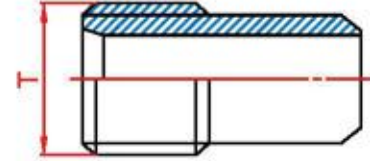
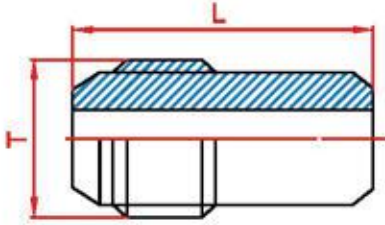

UNF Kaynaklık Nipeller

Dış Ölçüsü	Boy Ölçüsü (mm)	Fiyat
1/2" - 20	28,5	2,20 TL
9/16" - 18	33	2,20 TL
5/8" - 18	35	2,50 TL
3/4" - 16	40	2,70 TL
7/8" - 14	40	3,80 TL
1" 1/16 - 12	50	5,60 TL
1" 5/16 - 12	55	6,80 TL

BSP Erkek Kaynaklık Nipeller

Dış Ölçüsü	Boy Ölçüsü (mm)	Fiyat
R1/4" - 19	25	3,20 TL
R3/8" - 19	27	3,20 TL
R1/2" - 14	30	3,60 TL
R3/4" - 14	32	6,50 TL
R1" - 11	35	8,80 TL
R1" 1/4 - 11	40	11,00 TL
R1" 1/2 - 11	44	15,40 TL
R2" - 11	45	22,20 TL
R2" 1/2 - 11	45	40,20 TL
R3" - 11	45	55,40 TL

GÜNCEL FİYAT BİLGİSİ İÇİN İLETİŞİME GEÇİNİZ

Metrik Kaynaklık Nipeller

L Tipi	Dış Ölçüsü		Fiyat
	M12x1.5	6L	2,40 TL
	M14x1.5	8L	2,40 TL
	M16x1.5	10L	2,70 TL
	M18x1.5	12L	2,70 TL
	M22x1.5	15L	3,20 TL
	M26x1.5	18L	4,60 TL
	M30x2	22L	6,80 TL
	M36x2	28L	9,20 TL
	M45x2	35L	13,80 TL
M52x2	42L	18,40 TL	

S Tipi	Dış Ölçüsü		Fiyat
	M20x1.5	12S	2,80 TL
	M24x1.5	16S	3,50 TL
	M30x2	20S	5,70 TL
	M36x2	25S	8,10 TL
	M42x2	30S	12,70 TL
M52x2	38S	18,35 TL	

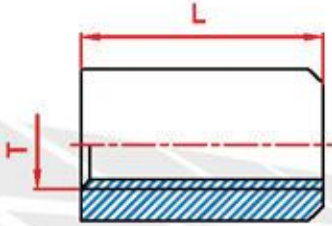
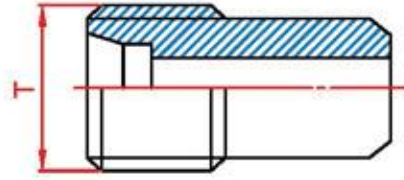

BSP Kaynaklı Maşonlar

T	L	Fiyat
R1/4" - 19	14	2,60 TL
R3/8" - 19	14	3,00 TL
R1/2" - 14	17	4,30 TL
R3/4" - 14	20	5,70 TL
R1" - 11	23	7,80 TL

BSP Altı Köşe Maşonlar

T2	CH	Fiyat
R1/8" - 28	14	2,60 TL
R1/4" - 19	17	2,80 TL
R3/8" - 19	22	3,20 TL
R1/2" - 14	27	4,80 TL
R3/4" - 14	32	6,50 TL
R1" - 11	41	10,20 TL
R1" 1/4 - 11	50	21,40 TL
R1" 1/2 - 11	55	32,20 TL

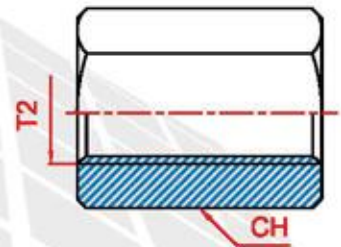

GÜNCEL FİYAT BİLGİSİ İÇİN İLETİŞİME GEÇİNİZ

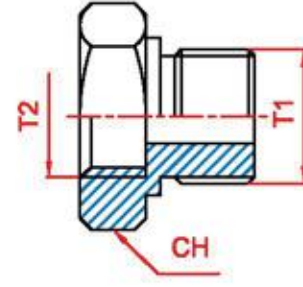
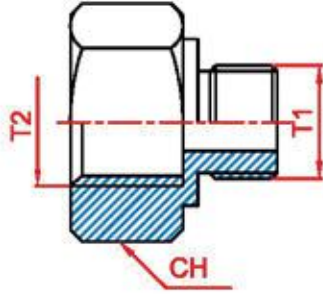

BSP Uzun Tip Redüksiyonlar

T2	T1	CH	Fiyat
R1/8-28	R1/8-28	14	4,00 TL
R1/8-28	R1/4-19	19	4,00 TL
R1/4-19	R1/8-28	19	4,00 TL
R1/4-19	R1/4-19	19	4,00 TL
R1/4-19	R3/8-19	24	4,60 TL
R1/4-19	R1/2-14	30	6,00 TL
R3/8-19	R1/4-19	24	5,20 TL
R3/8-19	R3/8-19	24	5,20 TL
R3/8-19	R1/2-14	30	6,30 TL
R3/8-19	R3/4-14	36	10,80 TL
R1/2-14	R3/8-19	30	6,50 TL
R1/2-14	R1/2-14	30	6,50 TL
R1/2-14	R3/4-14	36	10,20 TL
R1/2-14	R1"-11	41	14,60 TL
R3/4-14	R1/2-14	36	11,00 TL
R3/4-14	R1"-11	41	22,70 TL
R3/4-14	R1" 1/4-11	55	22,70 TL
R1"-11	R3/4-14	41	14,60 TL
R1"-11	R1" 1/4-11	55	22,70 TL
R1"-11	R1" 1/2-11	60	38,60 TL
R1" 1/4-11	R1"-11	55	34,80 TL
R1" 1/4-11	R1" 1/2-11	60	34,80 TL
R1" 1/2-11	R1" 1/4-11	60	34,80 TL

BSP Kısa Tip Redüksiyonları

T2	T1	CH	Fiyat
R1/4" - 19	R1/8" - 28	19	3,40 TL
R3/8" - 19	R1/8" - 19	22	3,90 TL
R3/8" - 19	R1/4" - 19	22	3,90 TL
R1/2" - 14	R1/4" - 19	27	4,60 TL
R1/2" - 14	R3/8" - 19	27	4,60 TL
R3/4" - 14	R3/8" - 19	32	6,50 TL
R3/4" - 14	R1/2" - 14	32	6,50 TL
R1" - 11	R1/2" - 14	41	11,30 TL
R1" - 11	R3/4" - 14	41	11,30 TL
R1" 1/4 - 11	R3/4" - 14	50	17,30 TL
R1" 1/4 - 11	R1" - 11	50	17,30 TL
R1" 1/2 - 11	R1" - 11	55	30,80 TL
R1" 1/2 - 11	R1" 1/4 - 11	55	30,80 TL

GÜNCEL FİYAT BİLGİSİ İÇİN İLETİŞİME GEÇİNİZ

BSP-Metrik Nipeller (Oringli)

L Tipi	T	T1	CH	Fiyat
	R1/8" - 28	M10x1.6LL	14	3,40 TL
	R1/8" - 28	M12x1.5 6L	14	3,40 TL
	R1/8" - 28	M14x1.5 8L	14	3,40 TL
	R1/8" - 28	M16x1.5 10L	17	3,40 TL
	R1/4" - 19	M12x1.5 6L	19	3,40 TL
	R1/4" - 19	M14x1.5 8L	19	3,40 TL
	R1/4" - 19	M16x1.5 10L	19	3,40 TL
	R1/4" - 19	M18x1.5 12L	19	3,40 TL
	R3/8" - 19	M12x1.5 6L	22	4,40 TL
	R3/8" - 19	M14x1.5 8L	22	4,00 TL
	R3/8" - 19	M16x1.5 10L	22	4,00 TL
	R3/8" - 19	M18x1.5 12L	22	4,00 TL
	R3/8" - 19	M22x1.5 15L	22	4,30 TL
	R1/2" - 14	M12x1.5 6L	27	6,00 TL
	R1/2" - 14	M14x1.5 8L	27	5,60 TL
	R1/2" - 14	M16x1.5 10L	27	5,60 TL
	R1/2" - 14	M18x1.5 12L	27	5,60 TL
	R1/2" - 14	M22x1.5 15L	27	5,60 TL
	R1/2" - 14	M26x1.5 18L	27	5,60 TL
R1/2" - 14	M30x2.22L	27	8,00 TL	
R3/4" - 14	M18x1.5 12L	32	9,20 TL	
R3/4" - 14	M22x1.5 15L	32	9,20 TL	
R3/4" - 14	M26x1.5 18L	32	8,00 TL	
R3/4" - 14	M30x2.22L	32	8,00 TL	
R3/4" - 14	M36x2.28L	36	17,00 TL	
R1" - 11	M30x2.22L	41	17,00 TL	
R1" - 11	M36x2.28L	41	15,00 TL	
R1" - 11	M45x2.35L	46	23,20 TL	
R1" 1/4 - 11	M36x2.28L	50	38,60 TL	
R1" 1/4 - 11	M45x2.35L	50	28,00 TL	
R1" 1/4 - 11	M52x2.42L	55	36,00 TL	
R1" 1/2 - 11	M45x2.35L	55	46,00 TL	
R1" 1/2 - 11	M52x2.42L	55	36,00 TL	

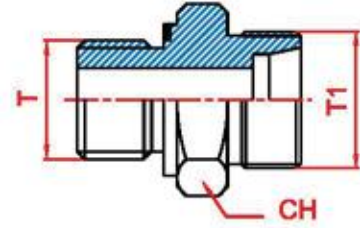

S Tipi	T	T1	CH	Fiyat
	R1/8 - 28	M14x1.5 6S	14	4,60 TL
	R1/4" - 19	M14x1.5 6S	19	4,50 TL
	R1/4" - 19	M16x1.5 8S	19	4,50 TL
	R1/4" - 19	M18x1.5 10S	19	4,50 TL
	R1/4" - 19	M20x1.5 12S	22	4,50 TL
	R3/8" - 19	M16x1.5 8S	22	4,80 TL
	R3/8" - 19	M18x1.5 10S	22	5,00 TL
	R3/8" - 19	M20x1.5 12S	22	4,50 TL
	R3/8" - 19	M24x1.5 16S	27	5,50 TL
	R1/2" - 14	M20x1.5 12S	27	5,20 TL
	R1/2" - 14	M24x1.5 16S	27	5,20 TL
	R1/2" - 14	M30x2.20S	32	9,20 TL
	R3/4" - 14	M24x1.5 16S	32	8,60 TL
	R3/4" - 14	M30x2.20S	32	8,60 TL
	R3/4" - 14	M36x2.25S	36	14,00 TL
	R1" - 11	M24x1.5 16S	41	17,00 TL
	R1" - 11	M30x2.20S	41	15,50 TL
	R1" - 11	M36x2.25S	41	15,50 TL
	R1" - 11	M42x2.30S	46	22,00 TL
R1" 1/4 - 11	M30x2.20S	50	39,00 TL	
R1" 1/4 - 11	M36x2.25S	50	39,00 TL	
R1" 1/4 - 11	M42x2.30S	50	26,80 TL	
R1" 1/4 - 11	M52x2.38S	55	42,00 TL	
R1" 1/2 - 11	M36x2.25S	55	46,00 TL	
R1" 1/2 - 11	M42x2.30S	55	46,00 TL	
R1" 1/2 - 11	M52x2.38S	55	36,00 TL	

GÜNCEL FİYAT BİLGİSİ İÇİN İLETİŞİME GEÇİNİZ

Metrik Ara Nipeller

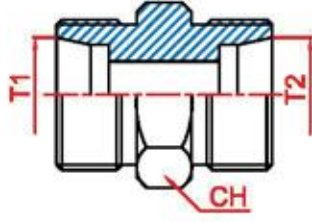

T1-2	CH	Fiyat
M10x1 6LL	12	4,00 TL
M12x1,5 6L	12	2,70 TL
M14x1,5 8L	14	2,70 TL
M16x1,5 10L	17	2,70 TL
M18x1,5 12L	19	2,90 TL
M22x1,5 15L	22	4,30 TL
M26x1,5 18L	27	6,00 TL
M30x2 22L	32	8,60 TL
M36x2 28L	36	14,60 TL
M45x2 35L	46	19,40 TL
M52x2 42L	55	36,00 TL

T1-2	CH	Fiyat
M14x1,5 6S	14	3,80 TL
M16x1,5 8S	17	3,80 TL
M18x1,5 10S	19	3,80 TL
M20x1,5 12S	22	3,80 TL
M24x1,5 16S	24	5,10 TL
M30x2 20S	32	6,50 TL
M36x2 25S	36	13,20 TL
M42x2 30S	46	18,00 TL
M52x2 38S	55	42,00 TL

Metrik Orantı Nipelleri

L Tipi	T1	T2	Fiyat
	M14x1,5 8L	M12x1,5 6L	4,00 TL
	M16x1,5 10L	M12x1,5 6L	4,40 TL
	M16x1,5 10L	M14x1,5 8L	4,40 TL
	M18x1,5 12L	M12x1,5 6L	5,10 TL
	M18x1,5 12L	M14x1,5 8L	5,10 TL
	M18x1,5 12L	M16x1,5 10L	4,80 TL
	M22x1,5 15L	M16x1,5 10L	5,80 TL
	M22x1,5 15L	M18x1,5 12L	5,80 TL
	M26x1,5 18L	M16x1,5 10L	10,20 TL
	M26x1,5 18L	M18x1,5 12L	10,20 TL
	M26x1,5 18L	M22x1,5 15L	10,50 TL
	M30x2 22L	M14x1,5 8L	14,80 TL
	M30x2 22L	M22x1,5 15L	14,80 TL

S Tipi	T1	T2	Fiyat
	M24x1,5 16S	M20x1,5 12S	9,20 TL
	M30x2 20S	M24x1,5 16S	11,60 TL
	M36x2 25S	M24x1,5 16S	14,60 TL
	M36x2 25S	M30x2 20S	14,60 TL

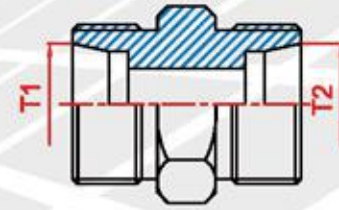

GÜNCEL FİYAT BİLGİSİ İÇİN İLETİŞİME GEÇİNİZ

Metrik Blok - Metrik 24° Nipeller

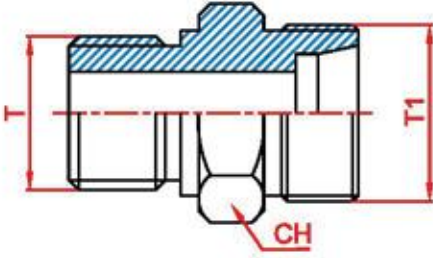

	T	T1	Fiyat
L Tipi	M12x1,5	M12x1,5 6L	2,70 TL
	M12x1,5	M14x1,5 8L	2,70 TL
	M14x1,5	M14x1,5 8L	2,90 TL
	M14x1,5	M16x1,5 10L	3,50 TL
	M14x1,5	M18x1,5 12L	3,50 TL
	M16x1,5	M14x1,5 8L	4,30 TL
	M16x1,5	M16x1,5 10L	4,30 TL
	M16x1,5	M18x1,5 12L	5,10 TL
	M18x1,5	M16x1,5 10L	5,10 TL
	M18x1,5	M18x1,5 12L	5,10 TL
	M18x1,5	M22x1,5 15L	4,60 TL
	M22x1,5	M14x1,5 8L	5,10 TL
	M22x1,5	M16x1,5 10L	5,10 TL
	M22x1,5	M18x1,5 12L	5,10 TL
	M22x1,5	M22x1,5 15L	5,10 TL
	M22x1,5	M26x1,5 18L	5,10 TL
S Tipi	T	T1	Fiyat
	M18x1,5	M20x1,5 12S	4,60 TL
M22x1,5	M24x1,5 16S	5,40 TL	

GÜNCEL FİYAT BİLGİSİ İÇİN İLETİŞİME GEÇİNİZ

BSP-UNF Nipeller

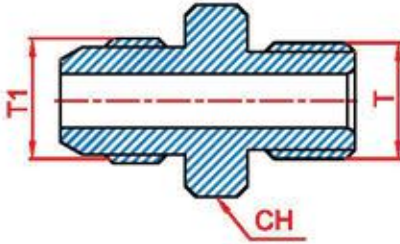

T	T1	CH	Fiyat
R1/8" - 28	7/16" - 20	14	3,40 TL
R1/4" - 19	7/16" - 20	19	3,40 TL
R1/4" - 19	1/2" - 20	19	3,40 TL
R1/4" - 19	9/16" - 18	19	3,20 TL
R1/4" - 19	5/8" - 18	22	3,40 TL
R1/4" - 19	3/4" - 16	22	4,20 TL
R3/8" - 19	7/16" - 20	19	4,20 TL
R3/8" - 19	1/2" - 20	19	4,20 TL
R3/8" - 19	9/16" - 18	19	4,20 TL
R3/8" - 19	5/8" - 18	22	4,20 TL
R3/8" - 19	3/4" - 16	22	4,20 TL
R3/8" - 19	7/8" - 14	24	5,75 TL
R1/2" - 14	1/2" - 20	24	5,75 TL
R1/2" - 14	9/16" - 18	24	5,75 TL
R1/2" - 14	5/8" - 18	24	5,75 TL
R1/2" - 14	3/4" - 16	27	5,75 TL
R1/2" - 14	7/8" - 14	27	5,75 TL
R1/2" - 14	1" 1/16 - 12	27	8,00 TL
R3/4" - 14	3/4" - 16	32	8,00 TL
R3/4" - 14	7/8" - 14	32	8,00 TL
R3/4" - 14	1" 1/16 - 12	32	8,00 TL
R3/4" - 14	1" 5/16 - 12	36	14,00 TL
R1" - 11	1" 1/16 - 12	41	15,00 TL
R1" - 11	1" 5/16 - 12	41	15,00 TL
R1" 1/4 - 11	1" 5/16 - 12	50	26,40 TL
R1" 1/4 - 11	1" 5/8 - 12	50	26,40 TL
R1" 1/2 - 11	1" 7/8 - 12	55	26,40 TL

GÜNCEL FİYAT BİLGİSİ İÇİN İLETİŞİME GEÇİNİZ

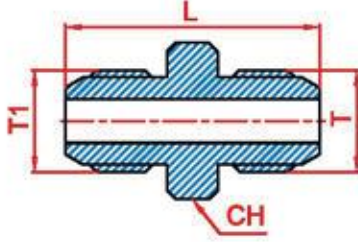

UNF-UNF Ara Nipeller

T	T1	CH	L	Fiyat
7/16" - 20	7/16" - 20	12	35	4,00 TL
1/2" - 20	1/2" - 20	14	35	4,00 TL
9/16" - 18	9/16" - 18	17	36	4,00 TL
5/8" - 18	5/8" - 18	22	38	4,00 TL
3/4" - 16	3/4" - 16	22	41	4,00 TL
7/8" - 14	7/8" - 14	24	48	6,60 TL
1" 1/16 - 12	1" 1/16 - 12	30	55	10,20 TL
1" 5/16 - 12	1" 5/16 - 12	36	57	16,00 TL
1" 5/8 - 12	1" 5/8 - 12	46	61.5	26,40 TL
1" 7/8 - 12	1" 7/8 - 12	50	70	34,00 TL

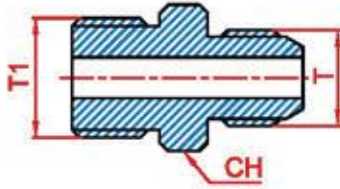

Metrik Blok - UNF Nipeller

T1	CH	T	Fiyat
M16x1.5	22	5/8" - 18	5,00 TL
M16x1.5	22	3/4" - 16	5,00 TL
M18x1.5	22	3/4" - 16	5,70 TL
M22x1.5	27	5/8" - 18	6,30 TL
M22x1.5	27	3/4" - 16	6,30 TL

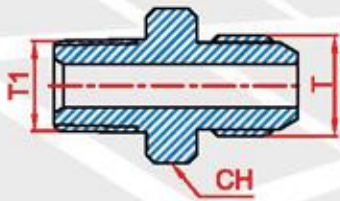

NPT - UNF Nipeller

T1	CH	T	Fiyat
1/8" - 28	12	7/16" - 20	3,50 TL
1/4" - 19	14	7/16" - 20	3,50 TL
1/4" - 19	14	1/2" - 20	3,50 TL
1/4" - 19	17	9/16" - 18	3,50 TL
1/4" - 19	17	5/8" - 18	3,50 TL
1/4" - 19	19	3/4" - 16	4,30 TL
3/8" - 19	19	9/16" - 18	4,30 TL
3/8" - 19	19	5/8" - 18	4,30 TL
3/8" - 19	19	3/4" - 16	4,30 TL
1/2" - 14	22	9/16" - 18	6,60 TL
1/2" - 14	22	5/8" - 18	6,60 TL
1/2" - 14	22	3/4" - 16	6,60 TL
1/2" - 14	24	7/8" - 14	6,60 TL
3/4" - 14	27	1" 1/16 - 12	9,00 TL

GÜNCEL FİYAT BİLGİSİ İÇİN İLETİŞİME GEÇİNİZ

BSP-BSP Orantılı Nipeller

T1	T	CH	Fiyat
1/8" - 28	1/4" - 19	19	4,00 TL
1/8" - 28	3/8" - 19	22	5,30 TL
1/4" - 19	3/8" - 19	22	4,70 TL
1/4" - 19	1/2" - 14	27	5,90 TL
1/4" - 19	3/4" - 14	32	9,60 TL
3/8" - 19	1/2" - 14	27	5,90 TL
3/8" - 19	3/4" - 14	32	9,20 TL
1/2" - 14	5/8" - 14	30	13,00 TL
1/2" - 14	3/4" - 14	32	8,500 TL
1/2" - 14	1" - 11	41	14,70 TL
5/8" - 14	3/4" - 14	32	10,70 TL
3/4" - 14	1" - 11	41	15,40 TL
3/4" - 14	1" 1/4 - 11	50	22,80 TL
1" - 11	1" 1/4 - 11	50	22,80 TL
1" - 11	1" 1/2 - 11	55	28,40 TL
1" 1/4 - 11	1" 1/2 - 11	55	28,40 TL
1" 1/4 - 11	2" - 11	65	60,00 TL
1" 1/2 - 11	2" - 11	65	36,20 TL
2" - 11	2" 1/2 - 11	70	115,00 TL
2" 1/2 - 11	3" - 11	75	125,00 TL

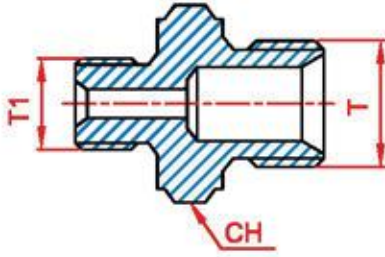

BSP-BSP Nipeller

T1	T	CH	L	Fiyat
1/8" - 28	1/8" - 28	14	25	3,20 TL
1/4" - 19	1/4" - 19	19	31	3,20 TL
3/8" - 19	3/8" - 19	22	35	4,00 TL
1/2" - 14	1/2" - 14	27	40	5,30 TL
5/8" - 14	5/8" - 14	32	42	10,50 TL
3/4" - 14	3/4" - 14	32	45.5	8,10 TL
1" - 11	1" - 11	41	52	13,10 TL
1" 1/4 - 11	1" 1/4 - 11	50	58	21,00 TL
1" 1/2 - 11	1" 1/2 - 11	55	64	26,40 TL
2" - 11	2" - 11	65	69	49,50 TL
2" 1/2 - 11	2" 1/2 - 11	82	76	100,00 TL
3" - 11	3" - 11	96	82	116,00 TL

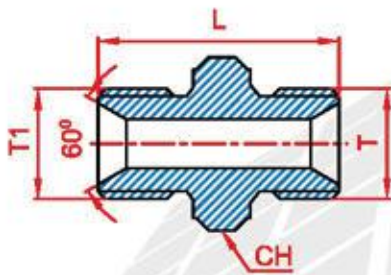

GÜNCEL FİYAT BİLGİSİ İÇİN İLETİŞİME GEÇİNİZ

BSP-ORFS Nipeller

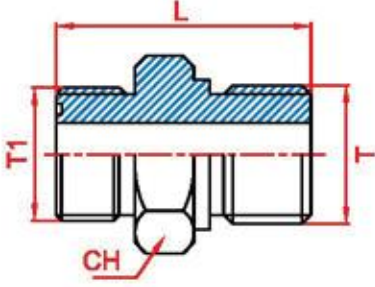

T	T1	CH	L	Fiyat
1/4" - 19	9/16" - 18	19	30.5	5,10 TL
1/4" - 19	11/16" - 16	19	32	5,10 TL
3/8" - 19	11/16" - 16	22	33	5,80 TL
3/8" - 19	13/16" - 16	22	34.5	7,00 TL
1/2" - 14	13/16" - 16	27	38.5	8,80 TL
1/2" - 14	1" - 14	27	41	8,80 TL
3/4" - 14	1" 3/16 - 12	32	46	11,80 TL
3/4" - 14	1" 7/16 - 12	41	53	18,30 TL
1" - 11	1" 7/16 - 12	41	49	20,60 TL
1" 1/4 - 11	1" 11/16 - 12	50	54	30,80 TL

BSP Blok - BSP Bombeli Nipeller

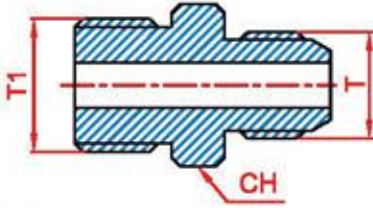

T1	CH	T	Fiyat
1/4" - 19	19	1/4" - 19	4,40 TL
3/8" - 19	22	3/8" - 19	5,50 TL
1/2" - 14	27	1/2" - 14	6,75 TL
3/4" - 14	32	3/4" - 14	10,00 TL
1" - 11	41	1" - 11	16,00 TL

BSP Bombeli - BSP Bombeli Nipeller

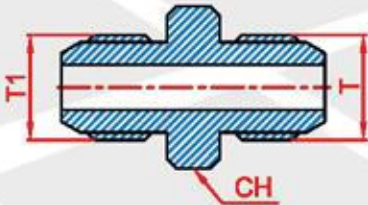

T1	CH	T	Fiyat
1/4" - 19	19	1/4" - 19	4,50 TL
3/8" - 19	22	3/8" - 19	5,60 TL
1/2" - 14	27	1/2" - 14	6,60 TL
3/4" - 14	32	3/4" - 14	9,50 TL
1" - 11	41	1" - 11	16,10 TL

GÜNCEL FİYAT BİLGİSİ İÇİN İLETİŞİME GEÇİNİZ

BSP - BSP Ters Nipeller

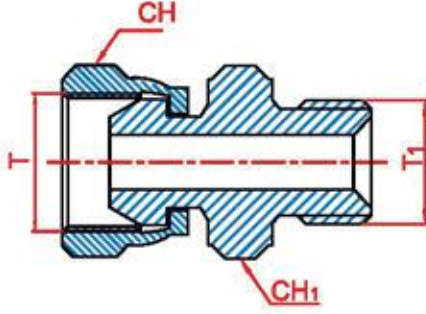

T1	T	CH	CH1	Fiyat
1/8" - 28	1/8" - 28	14	14	5,00 TL
1/4" - 19	1/4" - 19	19	19	5,40 TL
3/8" - 19	3/8" - 19	22	22	5,70 TL
1/2" - 14	1/2" - 14	27	27	7,60 TL
3/4" - 14	3/4" - 14	32	32	12,40 TL
1" - 11	1" - 11	41	41	19,10 TL
1" 1/4 - 11	1" 1/4 - 11	50	50	32,40 TL
1" 1/2 - 11	1" 1/2 - 11	55	55	40,30 TL

BSP - UNF Ters Nipeller

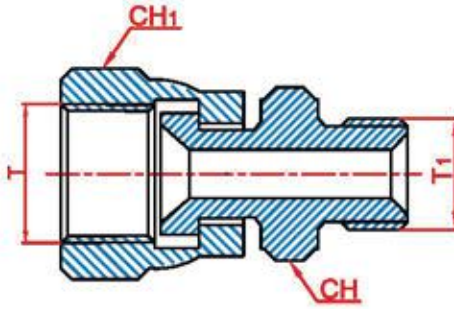

T1	T	CH	CH1	Fiyat
1/8" - 28	7/16" - 20	14	15	6,80 TL
1/4" - 19	7/16" - 20	19	17	5,90 TL
1/4" - 19	1/2" - 20	19	17	5,90 TL
1/4" - 19	9/16" - 18	19	19	5,90 TL
3/8" - 19	9/16" - 18	22	19	6,95 TL
3/8" - 19	5/8" - 18	22	22	6,95 TL
3/8" - 19	3/4" - 16	22	24	8,10 TL
1/2" - 14	9/16" - 18	27	22	10,70 TL
1/2" - 14	5/8" - 18	27	24	10,70 TL
1/2" - 14	3/4" - 16	27	27	10,70 TL
1/2" - 14	7/8" - 14	32	27	9,90 TL
3/4" - 14	7/8" - 14	32	32	9,90 TL
3/4" - 14	1" 1/16 - 12	41	32	17,60 TL
1" - 11	1" 1/16 - 12	41	41	26,40 TL
1" - 11	1" 5/16 - 12			25,60 TL

BSP - ORFS Ters Nipeller

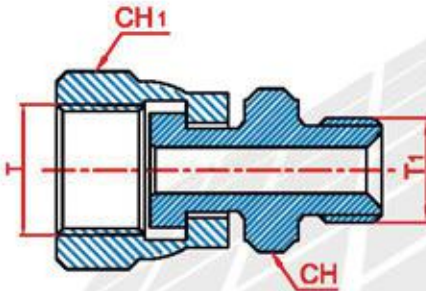

T1	T	CH	CH1	Fiyat
1/4" - 19	9/16" - 18	19	19	8,10 TL
1/4" - 19	11/16" - 16	19	22	8,10 TL
3/8" - 19	11/16" - 16	22	22	8,80 TL
3/8" - 19	13/16" - 16	22	24	9,50 TL
1/2" - 14	13/16" - 16	27	24	11,00 TL
1/2" - 14	1" - 14	27	30	11,70 TL
3/4" - 14	1" 3/16 - 12	32	36	17,60 TL
3/4" - 14	1" 7/16 - 12	41	41	24,90 TL
1" - 11	1" 7/16 - 12	41	41	24,00 TL
1" 1/4 - 11	1" 11/16 - 12	50	50	47,00 TL

GÜNCEL FİYAT BİLGİSİ İÇİN İLETİŞİME GEÇİNİZ

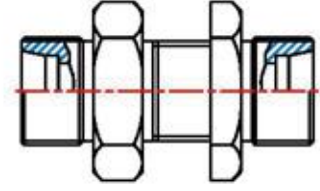

BSP Perde Geçiş Nipelleri

T1 - T2	CH1 - CH2	Fiyat
1/4" - 19	19	13,80 TL
3/8" - 19	22	15,60 TL
1/2" - 14	27	20,00 TL
3/4" - 14	32	27,00 TL
1" - 11	41	33,80 TL

Metrik Perde Geçiş Nipelleri

L Tipi	Dış Ölçüsü Boru Çapı	Fiyat
	M12x1.5 6L	7,80 TL
	M14x1.5 8L	7,80 TL
	M16x1.5 10L	7,80 TL
	M18x1.5 12L	8,10 TL
	M22x1.5 15L	10,50 TL
	M26x1.5 18L	14,60 TL
	M30x2 22L	20,00 TL
	M36x2 28L	32,40 TL
	M45x2 35L	46,00 TL
M52x2 42L	77,00 TL	

S Tipi	Dış Ölçüsü Boru Çapı	Fiyat
	M14x1,5 6S	10,00 TL
	M16x1,5 8S	8,60 TL
	M18x1,5 10S	8,60 TL
	M20x1,5 12S	10,00 TL
	M24x1,5 16S	13,20 TL
	M30x2 20S	18,90 TL
	M36x2 25S	32,40 TL
	M42x2 30S	50,00 TL
	M52x2 38S	78,30 TL

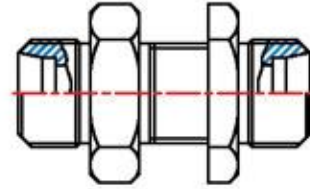

UNF Perde Geçiş Nipelleri

T1 - T2	CH1 - CH2	Fiyat
7/16"-20	14	11,90 TL
1/2"-20	19	12,10 TL
9/16"-18	19	13,20 TL
3/4"-16	22	16,00 TL
7/8"-14	27	22,70 TL
1" 1/16-12	32	27,50 TL
1" 5/16-12	41	36,20 TL

GÜNCEL FİYAT BİLGİSİ İÇİN İLETİŞİME GEÇİNİZ

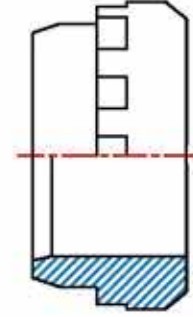
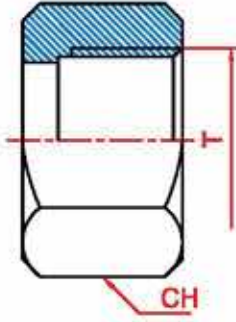

Boru Somunları

L Tipi	T		CH	Fiyat
	M	LL		
	M10x1	6LL		0,19 TL
	M12x1	8LL		0,21 TL
	M12x1,5	6L	14	0,17 TL
	M14x1,5	8L	17	0,22 TL
	M16x1,5	10L	19	0,22 TL
	M18x1,5	12L	22	0,25 TL
	M22x1,5	15L	27	0,40 TL
	M26x1,5	18L	32	0,57 TL
	M30x2	22L	36	0,74 TL
	M36x2	28L	41	1,05 TL
	M45x2	35L	50	1,64 TL
	M52x2	42L	60	2,77 TL

S Tipi	Somun Ölçüsü		CH	Fiyat
	M	S		
	M14x1,5	6S		0,26 TL
	M16x1,5	8S		0,32 TL
	M18x1,5	10S		0,44 TL
	M20x1,5	12S	24	0,39 TL
	M22x1,5	14S		0,64 TL
	M24x1,5	16S	30	0,55 TL
	M30x2	20S	36	0,75 TL
	M36x2	25S	46	1,26 TL
	M42x2	30S	50	1,66 TL
	M52x2	38S	55	2,70 TL

Çelik Yüksükler STEINER

L Tipi	Boru Çapı (mm)		Fiyat
	6LL	8LL	
	6		0,15 TL
	8		0,16 TL
	10		0,22 TL
	12		0,23 TL
	15		0,30 TL
	18		0,41 TL
	22		0,64 TL
	28		0,78 TL
	35		1,40 TL
	42		1,58 TL

S Tipi	Boru Çapı (mm)		Fiyat
	16	20	
	25		0,76 TL
	30		1,07 TL
	38		1,59 TL

GÜNCEL FİYAT BİLGİSİ İÇİN İLETİŞİME GEÇİNİZ

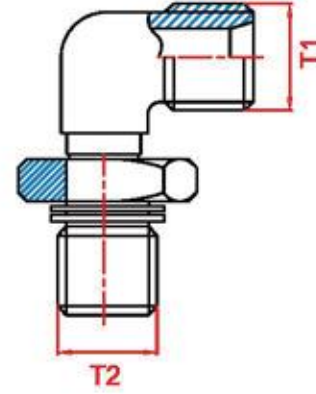
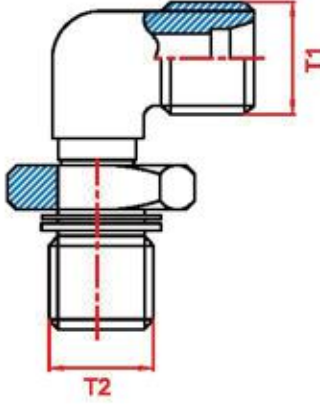

BSP-Metrik Kontrolü Dirsekler

T2	T1	Fiyat
R1/8" - 28	M12x1.5 6L	15,75 TL
R1/4" - 19	M12x1.5 6L	15,75 TL
R1/4" - 19	M14x1.5 8L	15,75 TL
R1/4" - 19	M16x1.5 10L	15,75 TL
R1/4" - 19	M18x1.5 12L	15,75 TL
R3/8" - 19	M16x1.5 10L	17,97 TL
R3/8" - 19	M18x1.5 12L	17,97 TL
R1/2" - 14	M18x1.5 12L	22,40 TL
R1/2" - 14	M22x1.5 15L	22,40 TL
R1/2" - 14	M26x1.5 18L	33,60 TL
R3/4" - 14	M26x1,5 18L	38,90 TL
R3/4" - 14	M30x2 22L	38,90 TL
R1" - 11	M30x2 22L	60,75 TL
R1" - 11	M36x2 28L	60,75 TL
R1" 1/4 - 11	M45x2 35L	97,24 TL
R1" 1/4 - 11	M52x2 42L	121,60 TL
R1" 1/2 - 11	M52x2 42L	121,60 TL

BSP-BSP Kontrolü Dirsekler

T2	T1	Fiyat
1/8" - 28	1/8" - 28	17,98 TL
1/4" - 19	1/4" - 19	17,98 TL
3/8" - 19	3/8" - 19	20,15 TL
1/2" - 14	1/2" - 14	26,92 TL
3/4" - 14	3/4" - 14	46,68 TL
1" - 11	1" - 11	61,63 TL
1" 1/4 - 11	1" 1/4 - 11	109,40 TL
1" 1/2 - 11	1" 1/2 - 11	121,60 TL

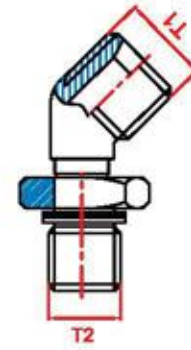

BSP-BSP Kontrolü Dirsekler

T2	T1	Fiyat
R3/8" - 19	M18x1.5 10S	22,40 TL
R3/8" - 19	M20x1.5 12S	22,40 TL
R1/2" - 14	M20x1.5 12S	22,40 TL
R1/2" - 14	M24x1.5 16S	22,40 TL
R1/2" - 14	M30x2 20S	46,68 TL
R3/4" - 14	M24x1.5 16S	37,34 TL
R3/4" - 14	M30x2 20S	42,00 TL
R3/4" - 14	M36x2 25S	63,00 TL
R1" - 11	M30x2 20S	63,00 TL
R1" - 11	M36x2 25S	63,00 TL
R1" - 11	M42x2 30S	97,25 TL
R1" 1/4 - 11	M42x2 30S	97,25 TL
R1" 1/4 - 11	M52x2 38S	121,60 TL
R1" 1/2 - 11	M52x2 38S	121,60 TL

T2	T1	Fiyat
1/8" - 28	1/8" - 28	22,40 TL
1/4" - 19	1/4" - 19	22,40 TL
3/8" - 19	3/8" - 19	25,20 TL
1/2" - 14	1/2" - 14	33,60 TL
3/4" - 14	3/4" - 14	58,35 TL
1" - 11	1" - 11	87,60 TL
1" 1/4 - 11	1" 1/4 - 11	131,25 TL
1" 1/2 - 11	1" 1/2 - 11	145,95 TL

**BAĞLANTI
ELEMENLARI**

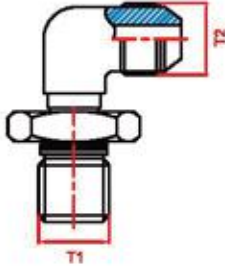

BSP-UNF Kontrolü Dirsekler

T1	T2	Fiyat
1/8-28	7/16-20	17,98 TL
1/4-19	7/16-20	17,98 TL
1/4-19	1/2-20	17,98 TL
1/4-19	9/16-18	17,98 TL
3/8-19	9/16-18	20,15 TL
3/8-19	5/8-18	20,15 TL
3/8-19	3/4-16	20,15 TL
1/2-14	9/16-18	26,92 TL
1/2-14	5/8-18	26,92 TL
1/2-14	3/4-16	26,92 TL
1/2-14	7/8-14	29,17 TL
1/2-14	1" 1/16-12	53,52 TL
3/4-14	7/8-14	48,62 TL
3/4-14	1" 1/16-12	48,62 TL
1"-11	1" 1/16-12	72,98 TL
1"-11	1" 5/16-12	72,98 TL



BSP-UNF Kontrolü Dirsekler

T1	T2	Fiyat
1/8-28	7/16-20	22,40 TL
1/4-19	7/16-20	22,40 TL
1/4-19	1/2-20	22,40 TL
1/4-19	9/16-18	22,40 TL
3/8-19	9/16-18	25,20 TL
3/8-19	5/8-18	25,20 TL
3/8-19	3/4-16	25,20 TL
1/2-14	9/16-18	33,60 TL
1/2-14	5/8-18	33,60 TL
1/2-14	3/4-16	33,60 TL
1/2-14	7/8-14	35,00 TL
1/2-14	1" 1/16-12	64,26 TL
3/4-14	7/8-14	58,35 TL
3/4-14	1" 1/16-12	58,35 TL
1"-11	1" 1/16-12	87,60 TL
1"-11	1" 5/16-12	87,60 TL

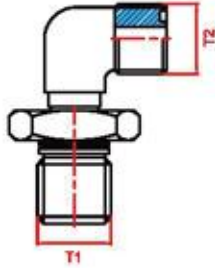

BSP-ORFS Kontrolü Dirsekler

T1	T2	Fiyat
R1/4-19	9/16-18	22,40 TL
R1/4-19	11/16-16	22,40 TL
R1/4-19	13/16-16	22,40 TL
R3/8-19	9/16-18	25,20 TL
R3/8-19	11/16-16	25,20 TL
R3/8-19	13/16-16	25,20 TL
R1/2-14	11/16-16	33,60 TL
R1/2-14	13/16-16	33,60 TL
R1/2-14	1" - 14	35,00 TL
R3/4-14	1" - 14	52,59 TL
R3/4-14	1" 3/16-12	52,59 TL
R3/4-14	1" 7/16-12	87,60 TL
R1" - 11	1" 3/16-12	87,60 TL
R1" - 11	1" 7/16-12	87,60 TL



BSP-ORFS Kontrolü Dirsekler

T1	T2	Fiyat
R1/4-19	9/16-18	22,40 TL
R1/4-19	11/16-16	22,40 TL
R1/4-19	13/16-16	22,40 TL
R3/8-19	9/16-18	25,20 TL
R3/8-19	11/16-16	25,20 TL
R3/8-19	13/16-16	25,20 TL
R1/2-14	11/16-16	33,60 TL
R1/2-14	13/16-16	33,60 TL
R1/2-14	1" - 14	35,00 TL
R3/4-14	1" - 14	52,59 TL
R3/4-14	1" 3/16-12	52,59 TL
R3/4-14	1" 7/16-12	87,60 TL
R1" - 11	1" 3/16-12	87,60 TL
R1" - 11	1" 7/16-12	87,60 TL

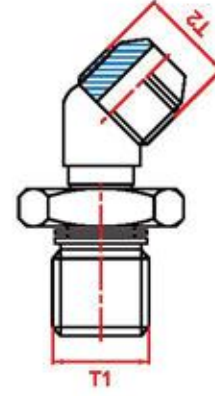
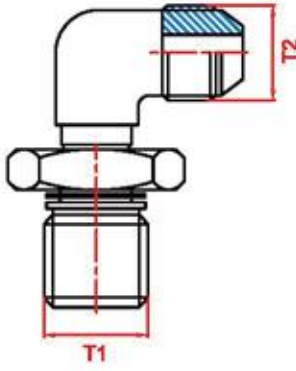

T1	T2	Fiyat
7/16-20	7/16-20	17,98 TL
1/2-20	1/2-20	17,98 TL
9/16-18	9/16-18	17,98 TL
5/8-18	5/8-18	22,40 TL
3/4-16	3/4-16	26,92 TL
7/8-14	7/8-14	29,17 TL
1" 1/16-12	1" 1/16-12	44,81 TL
1" 5/16-12	1" 5/16-12	67,22 TL

T1	T2	Fiyat
7/16-20	7/16-20	22,40 TL
1/2-20	1/2-20	22,40 TL
9/16-18	9/16-18	22,40 TL
5/8-18	5/8-18	28,00 TL
3/4-16	3/4-16	33,60 TL
7/8-14	7/8-14	36,41 TL
1" 1/16-12	1" 1/16-12	56,00 TL
1" 5/16-12	1" 5/16-12	87,00 TL

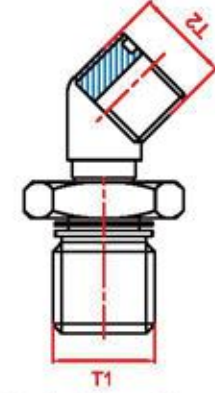
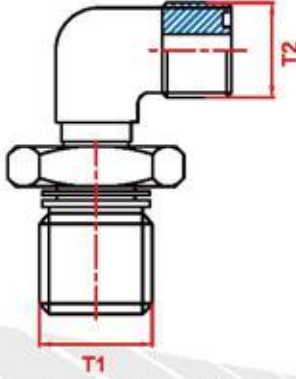

UNF-ORFS Kontrolü Dirsekler

T1	T2	Fiyat
9/16-18	9/16-18	17,98 TL
9/16-18	11/16-16	17,98 TL
9/16-18	13/16-16	17,98 TL
3/4-16	11/16-16	26,92 TL
3/4-16	13/16-16	26,92 TL
3/4-16	1" -14	26,92 TL
7/8-14	11/16-16	26,92 TL
7/8-14	13/16-16	26,92 TL
7/8-14	1" - 14	26,92 TL
1" 1/16-12	1" - 14	40,37 TL
1" 1/16-12	1" 3/16-12	40,37 TL
1" 1/16-12	1" 7/16-12	67,22 TL
1" 5/16-12	1" 3/16-12	67,22 TL
1" 5/16-12	1" 7/16-12	67,22 TL

UNF-ORFS Kontrolü Dirsekler

T1	T2	Fiyat
9/16-18	9/16-18	22,40 TL
9/16-18	11/16-16	22,40 TL
9/16-18	13/16-16	22,40 TL
3/4-16	11/16-16	33,60 TL
3/4-16	13/16-16	33,60 TL
3/4-16	1" -14	33,60 TL
7/8-14	11/16-16	33,60 TL
7/8-14	13/16-16	33,60 TL
7/8-14	1" - 14	33,60 TL
1" 1/16-12	1" - 14	50,41 TL
1" 1/16-12	1" 3/16-12	50,41 TL
1" 1/16-12	1" 7/16-12	84,00 TL
1" 5/16-12	1" 3/16-12	84,00 TL
1" 5/16-12	1" 7/16-12	84,00 TL

Metrik Perde Geçiş Dirsekleri

L Tipi	Dış Ölçüsü Boru Çapı		Fiyat
	M12x1.5	6L	15,72 TL
	M14x1.5	8L	15,72 TL
	M16x1.5	10L	15,72 TL
	M18x1.5	12L	19,05 TL
	M22x1.5	15L	26,92 TL
	M26x1.5	18L	33,60 TL
	M30x2	22L	53,76 TL
	M36x2	28L	67,22 TL

S Tipi	Dış Ölçüsü Boru Çapı		Fiyat
	M14x1.5	6S	17,98 TL
	M16x1.5	8S	19,05 TL
	M18x1.5	10S	22,40 TL
	M20x1.5	12S	20,15 TL
	M24x1.5	16S	26,92 TL
	M30x2	20S	44,81 TL
M36x2	25S	74,00 TL	

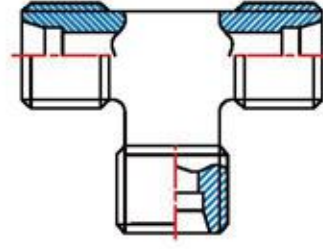
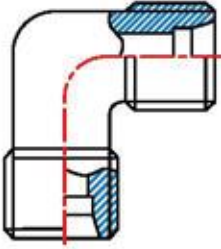
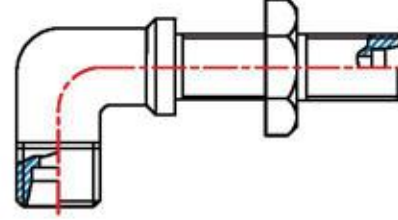

Metrik Dirsekler

L Tipi	Dış Ölçüsü		Fiyat
	M12x1.5	6L	8,35 TL
	M14x1.5	8L	8,35 TL
	M16x1.5	10L	7,98 TL
	M18x1.5	12L	8,72 TL
	M22x1.5	15L	13,00 TL
	M26x1.5	18L	16,15 TL
	M30x2	22L	18,77 TL
	M36x2	28L	27,95 TL
M45x2	35L	57,96 TL	
M52x2	42L	85,90 TL	

S Tipi	Dış Ölçüsü		Fiyat
	M14x1.5	6S	8,86 TL
	M16x1.5	8S	8,86 TL
	M18x1.5	10S	10,27 TL
	M20x1.5	12S	10,48 TL
	M24x1.5	16S	13,00 TL
	M30x2	20S	18,77 TL
	M36x2	25S	27,93 TL
	M42x2	30S	55,85 TL
M52x2	38S	85,90 TL	

Metrik TE Rakorlar

L Tipi	Dış Ölçüsü		Fiyat
	M12x1.5	6L	10,10 TL
	M14x1.5	8L	10,15 TL
	M16x1.5	10L	10,47 TL
	M18x1.5	12L	10,90 TL
	M22x1.5	15L	16,29 TL
	M26x1.5	18L	20,40 TL
	M30x2	22L	25,57 TL
	M36x2	28L	39,75 TL
M45x2	35L	66,60 TL	
M52x2	42L	96,60 TL	

S Tipi	Dış Ölçüsü		Fiyat
	M14x1.5	6S	11,28 TL
	M16x1.5	8S	11,60 TL
	M18x1.5	10S	11,90 TL
	M20x1.5	12S	12,00 TL
	M24x1.5	16S	17,54 TL
	M30x2	20S	24,57 TL
	M36x2	25S	39,75 TL
	M42x2	30S	66,60 TL
M52x2	38S	96,60 TL	

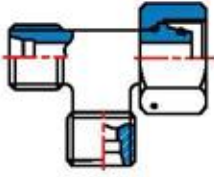
Metrik Yan Bacak TE Rakorlar

L Tipi	Dış Ölçüsü		Fiyat
	M12x1.5	6L	13,40 TL
	M14x1.5	8L	13,40 TL
	M16x1.5	10L	15,00 TL
	M18x1.5	12L	15,45 TL
	M22x1.5	15L	21,00 TL
	M26x1.5	18L	26,44 TL
	M30x2	22L	32,58 TL
	M36x2	28L	50,20 TL
	M45x2	35L	87,22 TL
M52x2	42L	118,10 TL	

S Tipi	Dış Ölçüsü		Fiyat
	M14x1.5	6S	17,42 TL
	M16x1.5	8S	18,98 TL
	M18x1.5	10S	19,60 TL
	M20x1.5	12S	18,45 TL
	M24x1.5	16S	23,24 TL
	M30x2	20S	31,20 TL
	M36x2	25S	48,70 TL
	M42x2	30S	85,90 TL
	M52x2	38S	118,10 TL

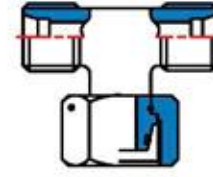
Metrik Orta Bacak TE Rakorlar

L Tipi	Dış Ölçüsü		Fiyat
	M12x1.5	6L	13,40 TL
	M14x1.5	8L	13,40 TL
	M16x1.5	10L	15,00 TL
	M18x1.5	12L	15,45 TL
	M22x1.5	15L	21,00 TL
	M26x1.5	18L	26,44 TL
	M30x2	22L	32,58 TL
	M36x2	28L	50,20 TL
	M45x2	35L	87,22 TL
M52x2	42L	118,10 TL	

S Tipi	Dış Ölçüsü		Fiyat
	M14x1.5	6S	17,42 TL
	M16x1.5	8S	18,98 TL
	M18x1.5	10S	19,60 TL
	M20x1.5	12S	18,45 TL
	M24x1.5	16S	23,24 TL
	M30x2	20S	31,20 TL
	M36x2	25S	48,70 TL
	M42x2	30S	85,90 TL
	M52x2	38S	118,10 TL

Metrik Ters Dirsekler

L Tipi	Dış Ölçüsü Boru Çapı	Somun Ölçüsü Boru Çapı	Fiyat	
	M12x1.5	6L	M12x1.5 6L	7,95 TL
	M14x1.5	8L	M14x1.5 8L	7,95 TL
	M16x1.5	10L	M16x1.5 10L	11,94 TL
	M18x1.5	12L	M18x1.5 12L	12,67 TL
	M22x1.5	15L	M22x1.5 15L	16,82 TL
	M26x1.5	18L	M26x1.5 18L	21,60 TL
	M30x2	22L	M30x2 22L	26,20 TL
	M36x2	28L	M36x2 28L	40,00 TL
	M45x2	35L	M45x2 35L	73,05 TL
M52x2	42L	M52x2 42L	89,70 TL	

S Tipi	Dış Ölçüsü Boru Çapı	Somun Ölçüsü Boru Çapı	Fiyat	
	M14x1.5	6S	M14x1.5 6S	13,45 TL
	M16x1.5	8S	M16x1.5 8S	14,72 TL
	M18x1.5	10S	M18x1.5 10S	18,36 TL
	M20x1.5	12S	M20x1.5 12S	15,07 TL
	M24x1.5	16S	M24x1.5 16S	17,97 TL
	M30x2	20S	M30x2 20S	25,26 TL
	M36x2	25S	M36x2 25S	42,94 TL
	M42x2	30S	M42x2 30S	65,97 TL
	M52x2	38S	M52x2 38S	87,90 TL

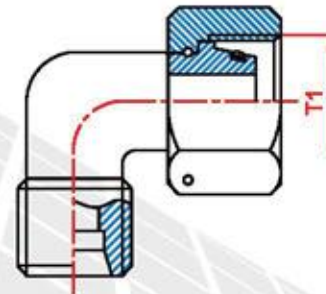

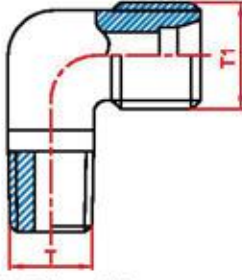

GÜNCEL FİYAT BİLGİSİ İÇİN İLETİŞİME GEÇİNİZ

NPT-Metrik Dirsekler

L Tipi	T	T1	Fiyat
	1/8" - 28 NPT	M10x1 6LL	9,34 TL
1/8" - 28 NPT	M12x1.5 6L	8,72 TL	
1/8" - 28 NPT	M14x1,5 8L	8,72 TL	
1/8" - 28 NPT	M16x1.5 10L	9,34 TL	
1/4" - 19 NPT	M12x1.5 6L	8,72 TL	
1/4" - 19 NPT	M14x1.5 8L	8,72 TL	
1/4" - 19 NPT	M16x1.5 10L	8,72 TL	
1/4" - 19 NPT	M18x1.5 12L	9,10 TL	
3/8" - 19 NPT	M12x1.5 6L	9,10 TL	
3/8" - 19 NPT	M14x1.5 8L	9,10 TL	
3/8" - 19 NPT	M16x1.5 10L	9,10 TL	
3/8" - 19 NPT	M18x1.5 12L	9,10 TL	
1/2" - 14 NPT	M16x1.5 10L	10,70 TL	
1/2" - 14 NPT	M18x1.5 12L	13,70 TL	
1/2" - 14 NPT	M22x1.5 15L	13,70 TL	
1/2" - 14 NPT	M26x1.5 18L	20,55 TL	
3/4" - 14 NPT	M30x2 22L	20,55 TL	
1" - 11 NPT	M36x2 28L	33,60 TL	
1" 1/4 - 11 NPT	M45x2 35L	52,28 TL	
1" 1/2 - 11 NPT	M52x2 42L	70,95 TL	

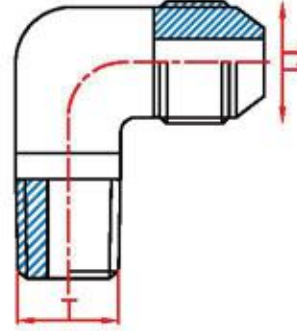

NPT-UNF Dirsekler

T	T1	Fiyat
1/8" - 28 NPT	7/16" - 20 UNF	9,35 TL
1/4" - 19 NPT	7/16" - 20 UNF	9,35 TL
1/4" - 19 NPT	1/2" - 20 UNF	9,35 TL
1/4" - 19 NPT	9/16" - 18 UNF	9,35 TL
1/4" - 19 NPT	5/8" - 18 UNF	10,30 TL
1/4" - 19 NPT	3/4" - 16 UNF	10,30 TL
3/8" - 19 NPT	1/2" - 20 UNF	10,30 TL
3/8" - 19 NPT	9/16" - 18 UNF	10,30 TL
3/8" - 19 NPT	5/8" - 18 UNF	10,30 TL
3/8" - 19 NPT	3/4" - 16 UNF	10,30 TL
1/2" - 14 NPT	9/16" - 18 UNF	14,00 TL
1/2" - 14 NPT	5/8" - 18 UNF	14,00 TL
1/2" - 14 NPT	3/4" - 16 UNF	14,00 TL
1/2" - 14 NPT	7/8" - 14 UNF	14,95 TL
1/2" - 14 NPT	1" 1/16 - 12 UNF	18,67 TL
3/4" - 14 NPT	3/4" - 16 UNF	18,67 TL
3/4" - 14 NPT	7/8" - 14 UNF	18,67 TL
3/4" - 14 NPT	1" 1/16 - 12 UNF	20,55 TL
1" - 11 NPT	1" 1/16 - 12 UNF	31,10 TL
1" - 11 NPT	1" 5/16 - 12 UNF	31,10 TL

S Tipi	T	T1	Fiyat
	1/4-19 NPT	M14x1,5 6S	9,88 TL
1/4-19 NPT	M16x1,5 8S	9,88 TL	
1/4-19 NPT	M18x1,5 10S	9,88 TL	
3/8-19 NPT	M16x1,5 8S	9,88 TL	
3/8-19 NPT	M18x1,5 10S	9,88 TL	
3/8-19 NPT	M20x1,5 12S	9,88 TL	
3/8-19 NPT	M24x1,5 16S	13,70 TL	
1/2-14 NPT	M20x1,5 12S	13,70 TL	
1/2-14 NPT	M24x1,5 16S	13,60 TL	
1/2-14 NPT	M30x2 20S	18,68 TL	
3/4-14 NPT	M24x1,5 16S	18,68 TL	
3/4-14 NPT	M30x2 20S	18,68 TL	
3/4-14 NPT	M36x2 25S	34,23 TL	
1"-11 NPT	M30x2 20S	31,75 TL	
1"-11 NPT	M36x2 25S	31,75 TL	
1"-11 NPT	M42x2 30S	48,55 TL	
1" 1/4-11 NPT	M42x2 30S	48,55 TL	
1" 1/4-11 NPT	M52x2 38S	65,35 TL	
1" 1/2-11 NPT	M52x2 38S	65,35 TL	

GÜNCEL FİYAT BİLGİSİ İÇİN İLETİŞİME GEÇİNİZ

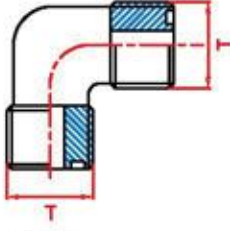

ORFS Dirsekler

T	Fiyat
9/16" - 18	10,30 TL
11/16" - 16	11,30 TL
13/16" - 16	12,45 TL
1" - 14	19,50 TL
1" 3/16 - 12	25,15 TL
1" 7/16 - 12	36,65 TL
1" 11/16 - 12	61,15 TL

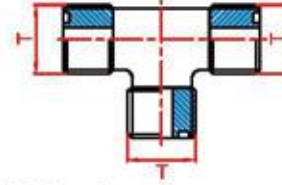

ORFS TE Rakorlar

T	Fiyat
9/16" - 18	12,37 TL
11/16" - 16	13,22 TL
13/16" - 16	14,00 TL
1" - 14	22,70 TL
1" 3/16 - 12	28,95 TL
1" 7/16 - 12	40,00 TL
1" 11/16 - 12	62,70 TL

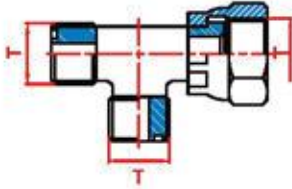

ORFS Yanbacak TE Rakorlar

T	Fiyat
9/16" - 18	14,40 TL
11/16" - 16	15,48 TL
13/16" - 16	17,05 TL
1" - 14	27,55 TL
1" 3/16 - 12	33,92 TL
1" 7/16 - 12	48,55 TL
1" 11/16 - 12	80,50 TL

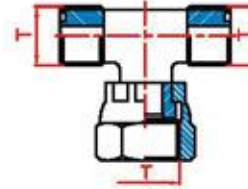

ORFS Ortabacak TE Rakorlar

T	Fiyat
9/16" - 18	14,40 TL
11/16" - 16	15,48 TL
13/16" - 16	17,05 TL
1" - 14	27,55 TL
1" 3/16 - 12	33,92 TL
1" 7/16 - 12	48,55 TL
1" 11/16 - 12	80,50 TL

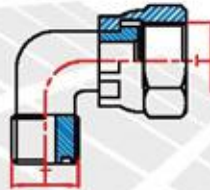

ORFS Ters Dirsekler

T	Fiyat
9/16" - 18	12,40 TL
11/16" - 16	14,00 TL
13/16" - 16	16,80 TL
1" - 14	26,05 TL
1" 3/16 - 12	32,20 TL
1" 7/16 - 12	48,30 TL
1" 11/16 - 12	80,50 TL

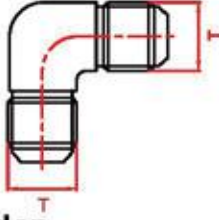

UNF Dirsekler

T	Fiyat
7/16" - 20 UNF	9,80 TL
1/2" - 20 UNF	9,80 TL
9/16" - 18 UNF	11,75 TL
5/8" - 18 UNF	11,75 TL
3/4" - 16 UNF	12,77 TL
7/8" - 14 UNF	15,72 TL
1" 1/16 - 12 UNF	19,60 TL
1" 5/16 - 12 UNF	39,22 TL
1" 5/8 - 12 UNF	58,80 TL
1" 7/8 - 12 UNF	105,75 TL

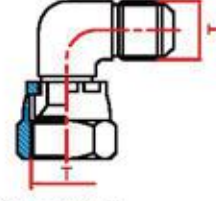

UNF Ters Dirsekler

T	Fiyat
7/16" - 20 UNF	10,80 TL
1/2" - 20 UNF	10,80 TL
9/16" - 18 UNF	10,80 TL
5/8" - 18 UNF	11,75 TL
3/4" - 16 UNF	12,77 TL
7/8" - 14 UNF	18,20 TL
1" 1/16 - 12 UNF	21,55 TL
1" 5/16 - 12 UNF	31,35 TL
1" 5/8 - 12 UNF	52,98 TL
1" 7/8 - 12 UNF	120,85 TL

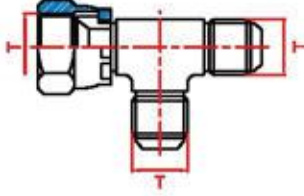

UNF Yanbacak TE Rakorlar

T	Fiyat
7/16" - 20 UNF	13,76 TL
1/2" - 20 UNF	13,76 TL
9/16" - 18 UNF	13,76 TL
5/8" - 18 UNF	13,76 TL
3/4" - 16 UNF	15,72 TL
7/8" - 14 UNF	19,60 TL
1" 1/16 - 12 UNF	23,57 TL
1" 5/16 - 12 UNF	39,21 TL
1" 5/8 - 12 UNF	78,45 TL
1" 7/8 - 12 UNF	157,55 TL

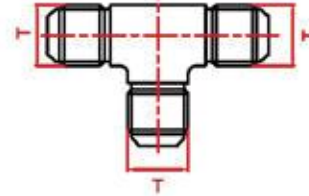

UNF TE Rakorlar

T	Fiyat
7/16" - 20 UNF	13,76 TL
1/2" - 20 UNF	13,76 TL
9/16" - 18 UNF	13,76 TL
5/8" - 18 UNF	13,76 TL
3/4" - 16 UNF	15,72 TL
7/8" - 14 UNF	19,60 TL
1" 1/16 - 12 UNF	23,57 TL
1" 5/16 - 12 UNF	39,21 TL
1" 5/8 - 12 UNF	78,45 TL
1" 7/8 - 12 UNF	157,55 TL

UNF Ortabacak TE Rakorlar

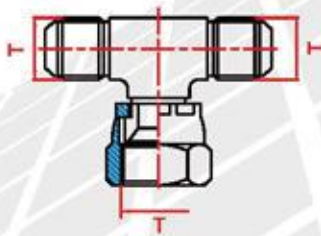

T	Fiyat
7/16" - 20 UNF	11,75 TL
1/2" - 20 UNF	11,75 TL
9/16" - 18 UNF	11,75 TL
5/8" - 18 UNF	11,75 TL
3/4" - 16 UNF	13,76 TL
7/8" - 14 UNF	25,40 TL
1" 1/16 - 12 UNF	23,80 TL
1" 5/16 - 12 UNF	37,26 TL
1" 5/8 - 12 UNF	62,25 TL
1" 7/8 - 12 UNF	151,00 TL

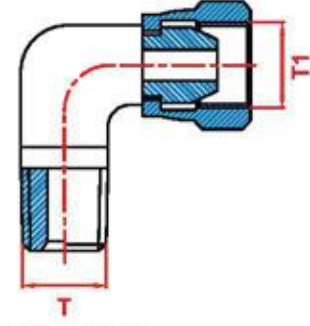
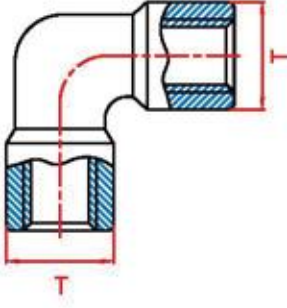

BSP Dirsekler

T	T1	Fiyat
1/8-28 NPT	R1/8-28	7,95 TL
1/4-19 NPT	R1/4-19	8,33 TL
3/8-19 NPT	R3/8-19	11,43 TL
1/2-14 NPT	R1/2-14	16,57 TL
3/4-14 NPT	R3/4-14	25,67 TL
1"-11 NPT	R1"-11	37,35 TL
1"1/4-11 NPT	R1"1/4-11	68,05 TL
1"1/2-11 NPT	R1"1/2-11	85,20 TL

BSP Ters Dirsekler

T	T1	Fiyat
1/8-28 NPT	R1/8-28	9,10 TL
1/4-19 NPT	R1/4-19	9,65 TL
3/8-19 NPT	R3/8-19	12,65 TL
1/2-14 NPT	R1/2-14	18,20 TL
3/4-14 NPT	R3/4-14	28,25 TL
1"-11 NPT	R1"-11	41,62 TL
1"1/4-11 NPT	R1"1/4-11	75,25 TL
1"1/2-11 NPT	R1"1/2-11	94,15 TL
R2"-11	R2"-11	173,65 TL

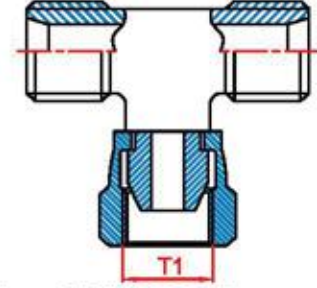
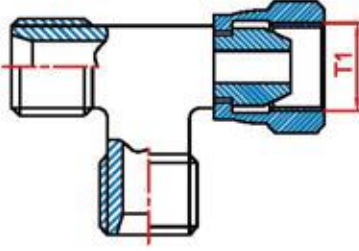

BSP Yanbacak TE Rakorlar

T	Fiyat
R1/8-28	12,92 TL
R1/4-19	16,80 TL
R3/8-19	18,05 TL
R1/2-14	42,30 TL
R3/4-14	33,55 TL
R1"-11	54,15 TL
R1"1/4-11	90,17 TL
R1"1/2-11	116,00 TL

BSP Ortabacak TE Rakorlar

T	Fiyat
R1/8-28	12,92 TL
R1/4-19	16,80 TL
R3/8-19	18,05 TL
R1/2-14	42,30 TL
R3/4-14	33,55 TL
R1"-11	54,15 TL
R1"1/4-11	90,17 TL
R1"1/2-11	116,00 TL

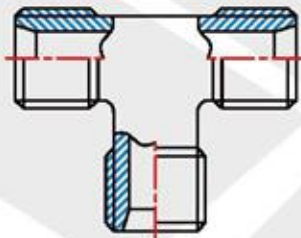

BSP TE Rakorlar

T	Fiyat
R1/8-28	9,25 TL
R1/4-19	14,25 TL
R3/8-19	14,77 TL
R1/2-14	21,25 TL
R3/4-14	29,80 TL
R1"-11	46,90 TL
R1"1/4-11	77,35 TL
R1"1/2-11	103,10 TL

GÜNCEL FİYAT BİLGİSİ İÇİN İLETİŞİME GEÇİNİZ

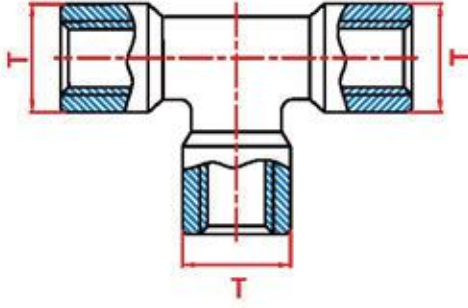

BSP Dişi TE Rakorlar

T	Fiyat
R1/8-28	9,73 TL
R1/4-19	11,50 TL
R3/8-19	15,35 TL
R1/2-14	22,10 TL
R3/4-14	33,85 TL
R1"-11	57,05 TL
R1"1/4-11	93,60 TL

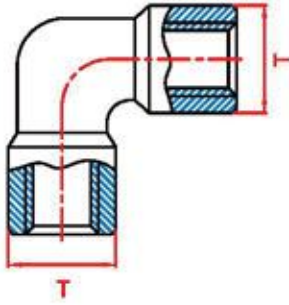

BSP Dişi Dirsekler

T	T1	Fiyat
1/8-28 NPT	R1/8-28	7,25 TL
1/4-19 NPT	R1/4-19	8,55 TL
3/8-19 NPT	R3/8-19	11,45 TL
1/2-14 NPT	R1/2-14	16,40 TL
3/4-14 NPT	R3/4-14	25,00 TL
1"-11 NPT	R1"-11	42,40 TL
1"1/4-11 NPT	R1"1/4-11	72,67 TL
1"1/2-11 NPT	R1"1/2-11	174,60 TL

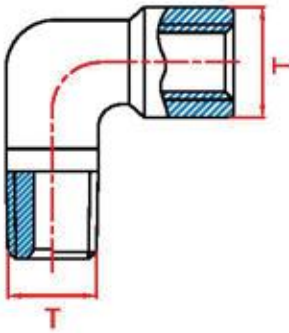

Kuyruklu Dirsekler

T	T1	Fiyat
1/8-28 NPT	R1/8-28	14,40 TL
1/4-19 NPT	R1/4-19	14,40 TL
3/8-19 NPT	R3/8-19	16,96 TL
1/2-14 NPT	R1/2-14	21,55 TL
3/4-14 NPT	R3/4-14	28,78 TL
1"-11 NPT	R1"-11	51,35 TL
1"1/4-11 NPT	R1"1/4-11	92,45 TL
1"1/2-11 NPT	R1"1/2-11	174,60 TL

GÜNCEL FİYAT BİLGİSİ İÇİN İLETİŞİME GEÇİNİZ

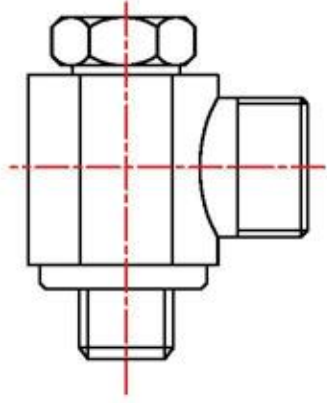

BSP-Metrik Döner Dirsekler

L Tipi	Dış Ölçüsü		Fiyat
	Dış Ölçüsü	Dış Ölçüsü Boru Çapı	
	1/8" - 28	M10x1 6LL	22,45 TL
	1/8" - 28	M12x1,5 6L	18,80 TL
	1/8" - 28	M14x1,5 8L	18,80 TL
	1/4" - 19	M12x1,5 6L	19,70 TL
	1/4" - 19	M14x1,5 8L	19,70 TL
	1/4" - 19	M16x1,5 10L	19,70TL
	1/4" - 19	M18x1,5 12L	19,70TL
	3/8" - 19	M12x1,5 6L	22,37 TL
	3/8" - 19	M14x1,5 8L	22,37 TL
	3/8" - 19	M16x1,5 10L	22,37 TL
	3/8" - 19	M18x1,5 12L	22,37 TL
	3/8" - 19	M22x1,5 15L	33,35 TL
	1/2" - 14	M16x1,5 10L	29,55 TL
	1/2" - 14	M18x1,5 12L	29,55 TL
	1/2" - 14	M22x1,5 15L	29,55 TL
	1/2" - 14	M26x1,5 18L	29,55 TL
	3/4" - 14	M26x1,5 18L	37,60 TL
	3/4" - 14	M30x2 22L	37,60 TL
	1" - 11	M36x2 28L	53,70 TL
	1" 1/4 - 11	M45x2 35L	102,95 TL
	1" 1/2 - 11	M52x2 42L	149,65 TL

S Tipi	Dış Ölçüsü		Fiyat
	Dış Ölçüsü	Dış Ölçüsü Boru Çapı	
	1/4-19	M14x1,5 6S	23,30 TL
	1/4-19	M16x1,5 8S	23,30 TL
	3/8-19	M18x1,5 10S	25,00 TL
	3/8-19	M20x1,5 12S	25,00 TL
	3/8-19	M24x1,5 16S	33,35 TL
	1/2-14	M20x1,5 12S	30,42 TL
	1/2-14	M24x1,5 16S	26,56 TL
	1/2-14	M30x2 20S	41,20 TL
	3/4-14	M24x1,5 16S	34,40 TL
	3/4-14	M30x2 20S	33,80 TL
	3/4-14	M36x2 25S	69,00 TL
	1"-11	M30x2 20S	57,50 TL
	1"-11	M36x2 25S	53,70 TL
	1"-11	M42x2 30S	89,70 TL
	1" 1/4-11	M42x2 30S	98,45 TL
	1" 1/4-11	M52x2 38S	171,35 TL
	1" 1/2-11	M52x2 38S	143,20 TL

NOTLAR

A series of horizontal dashed lines for taking notes, covering most of the page.



ankaflex

HİDROLİK PNÖMATİK MAKİNE LTD. ŞTİ.